



<http://www.chinakong.com> 中国工控网站收集整理

VS-616PC5/P5 Series User's Manual

Variable Torque Inverter

(with software version 5110/5120 and newer)

WARNING

PRECAUTIONS

- 1) Read this manual in its entirety before installing or operating the VS-616PC5/P5 inverter. This manual applies to inverters with software versions 5110 and 5120 only and is not intended to be used in conjunction with any other software.
- 2) Do not connect or disconnect wiring, or perform signal checks while the power supply is turned ON.
- 3) The VS-616PC5/P5 internal capacitor may be charged even after the power supply is turned OFF. To prevent electrical shock, disconnect all power before servicing the inverter. Then wait at least five minutes after the power supply is disconnected and all LEDs are extinguished.
- 4) Do not perform a withstand voltage test or a megger test on any part of the VS-616PC5/P5. This electronic equipment uses semiconductors and is vulnerable to high voltage.
- 5) Do not remove the operator unless the power supply is turned OFF. Never touch the printed control board while the power supply is turned ON.
- 6) The VS-616PC5/P5 is suitable for use on a circuit capable of delivering not more than 65,000 RMS symmetrical amperes, 480 Volts maximum (460V class units), 240 Volts maximum (230V class units).

Failure to observe these and other precautions highlighted in this manual will expose the user to high voltages, resulting in equipment damage, serious injury or death.

NOTICE

Printed April, 1999. The information contained within this document is the proprietary property of Yaskawa Electric America, Inc., and may not be copied, reproduced or transmitted to other parties without the expressed written authorization of Yaskawa Electric America, Inc.

No patent liability is assumed with respect to the use of the information contained herein. Moreover, because Yaskawa is constantly improving its high-quality products, the information contained in this manual is subject to change without notice. Every precaution has been taken in the preparation of this manual. Nevertheless, Yaskawa assumes no responsibility for errors or omissions. Neither is any liability assumed for damages resulting from the use of the information contained in this publication.

CONTENTS

<u>Section</u>	<u>Description</u>	<u>Page</u>
1	RECEIVING & INSTALLATION	
1.1	INTRODUCTION	6
1.2	SPECIFICATIONS.....	7
	VS-616PC5	7
	VS-616P5.....	9
1.3	PRELIMINARY INSPECTION	11
	Receiving	11
	Checking the Nameplate.....	11
	Identifying the Parts.....	12
1.4	MOUNTING.....	13
	Precautions.....	13
	Choosing a Location	13
	Removing and Replacing the Digital Operator	14
	Removing and Replacing the Front Cover.....	14
	Dimensions/Heat Loss.....	15
	Clearances	17
1.5	WIRING.....	18
	Precautions.....	18
	Inspection.....	18
	VS-616PC5 Connection Diagram	19
	VS-616P5 Connection Diagram.....	20
	Main Circuit Wiring	21
	Terminal Functions	24
	Wire and Terminal Screw Sizes	25
	Control Circuit Wiring.....	28
2	OPERATION	
	Precautions.....	30
2.1	TRIAL OPERATION.....	31
	Display at Power-up	31
	Operation Checkpoints	32
	Basic Operation	32
2.2	DIGITAL OPERATOR DISPLAY.....	35
2.3	LED DESCRIPTION	36
2.4	OPERATION MODE SELECTION.....	37
3	PROGRAMMING FEATURES	
3.1	VS-616PC5/P5 PARAMETERS (<i>n001~n116</i>)	41
3.2	PARAMETER SET-UP & INITIALIZATION.....	49
3.3	VS-616PC5/P5 OPERATION	50
	Accel/decel time adjustment.....	50
	Automatic fault retry	51
	Automatic restart after momentary power loss	51
	Carrier frequency.....	51

	Current limit (Stall prevention)	52
	DC injection braking	54
	Energy savings control	55
	Frequency agree set point	57
	Frequency meter or ammeter	58
	Frequency meter or ammeter calibration	58
	Frequency signal adjustment	58
	Jog operation	60
	Jump frequencies	60
	MODBUS communication	61
	Motor overload detection	62
	Multi-step speed selection	64
	Phase loss detection	65
	PID Control	66
	Reverse run prohibit	68
	Soft-start characteristics	68
	Speed limit adjustment	69
	Stopping method	70
	Torque adjustment	72
	Torque detection	73
	Triplex operation	74
	V/f pattern adjustment	75
	Slip compensation	77
3.4	INPUTS & OUTPUTS	78
	Multi-function input signals	78
	Analog input signals	82
	Multi-function output signals	83
4	DIAGNOSTICS	
	Precautions	86
4.1	MAINTENANCE & INSPECTION	87
	Periodic Inspection	87
	Parts Replacement Schedule	87
4.2	ALARM & FAULT DISPLAY	88
	Alarm Display	88
	Fault Display	89
	Motor Faults	92
A	APPENDIX	
A-1	BRAKING CONNECTION DIAGRAMS	94
A-2	DIGITAL OPERATOR MONITOR DISPLAY	95
A-3	CE CONFORMANCE	97

- CHAPTER 1 -

RECEIVING & INSTALLATION

<u>Section</u>	<u>Description</u>	<u>Page</u>
1	RECEIVING & INSTALLATION	
1.1	INTRODUCTION	6
1.2	SPECIFICATIONS	7
	VS-616PC5	7
	VS-616P5	9
1.3	PRELIMINARY INSPECTION	11
	Receiving	11
	Checking the Nameplate	11
	Identifying the Parts	12
1.4	MOUNTING	13
	Precautions	13
	Choosing a Location	13
	Removing and Replacing the Digital Operator	14
	Removing and Replacing the Front Cover	14
	Dimensions/Heat Loss	15
	Clearances	17
1.5	WIRING	18
	Precautions	18
	Inspection	18
	VS-616PC5 Connection Diagram	19
	VS-616P5 Connection Diagram	20
	Main Circuit Wiring	21
	Terminal Functions	24
	Wire and Terminal Screw Sizes	25
	Control Circuit Wiring	28

1.1 INTRODUCTION

The VS-616PC5/P5 is a series of high quality, variable torque inverters. With a power range of 5 to 500 HP, it provides all the functionality of prior series, in a compact, low cost package. This functionality includes Yaskawa proprietary features like full-range automatic torque boost, electronic thermal motor overload, energy savings and PID operation, low-noise operation and various other features. It also features a new digital operator for simple programming. Utilizing the latest microprocessor technology, members of Yaskawa's design team have collaborated to make the VS-616PC5/P5 the world's first optimized inverter specifically designed for variable torque applications.

This manual details installation, start-up and operating procedures for the VS-616PC5/P5 series adjustable frequency drive controller. Descriptions of diagnostic and troubleshooting procedures are also included herein.

1.2 SPECIFICATIONS

VS-616PC5

Inverter Model CIMR-P5U		VS-616PC5									
		20P4	20P7	21P5	22P2	23P7	25P5	27P5	2011	2015	-
Output Characteristics	Motor Output (HP) *	0.5	1	2	3	5	7.5	10	20	25	-
	Capacity (kVA)	1.2	2.3	3.0	4.2	6.7	9.5	13	19	24	-
	Rated Output Current (A)-VT**	3.2	6	8	11	17.5	27	36	54	68	-
	Rated Output Current (A)-CT**	3.2	6	8	11	17.5	25	33	49	64	-
	Max. Voltage	3-Phase, 200/208/220/230V (Proportional to input voltage)									
	Rated Output Frequency	0.1 to 400 Hz									
	Overload Capacity - VT	120% Rated Output Current for 1 minute									
	Overload Capacity - CT	150% Rated Output Current for 1 minute									
Power Supply	Input Current (A)	3.9	7.2	9.6	13.2	21	33	44	65	82	-
	Rated Voltage & Frequency	3-Phase 220 - 230V, 50/60Hz									
	Voltage Fluctuation	+10%, -15%									
	Frequency Fluctuation	±5%									
CIMR-P5U		40P4	40P7	41P5	42P2	43P7	44P0	45P5	47P5	4011	4015
Output Characteristics	Motor Output (HP) *	0.5	1	2	3	5	7.5	10	15	20	25
	Capacity (kVA)	1.4	2.6	3.7	4.7	6.1	8.6	11	14	21	26
	Rated Output Current (A)-VT**	1.9	3.6	5.1	6.6	8.5	11.7	14.8	21.0	28.6	34.0
	Rated Output Current (A)-CT**	1.9	3.6	5.1	6.6	8.5	11.7	14.8	18	28.6	34.0
	Max. Voltage #	3-Phase, 380/400/415/440/460V (Proportional to input voltage)									
	Rated Output Frequency	0.1 to 400 Hz									
	Overload Capacity-VT**	120% Rated Output Current for 1 minute (Model 47P5 is rated 150% / 1 minute)									
Overload Capacity-CT**	150% Rated Output Current for 1 minute										
Power Supply	Input Current (A)	2.3	4.3	6.1	8.0	10.2	14.0	17.8	26.0	35.0	40.0
	Rated Voltage & Frequency #	3-Phase 380 -440 - 460V, 50/60Hz									
	Voltage Fluctuation	+10%, -15%									
	Frequency Fluctuation	±5%									

* HP ratings based on standard NEMA 4-pole motor data.

For 380V operation, the motor rated current must be less than or equal to the inverter rated current.

** VT: Variable Torque rating (n116=1), CT: Constant Torque rating (n116=0)

Note: Shaded areas indicate factory settings.

Chapter 1 - Receiving & Installation
Specifications

Control Characteristics	Control Method	Sine wave PWM with full-range, automatic torque boost
	Frequency Control Range	0.1 to 400 Hz
	Frequency Accuracy	Digital command: 0.01%, Analog command: 0.1%
	Frequency Setting Resolution	Digital Operator Reference: 0.1Hz, Analog Reference: 0.06Hz (@60Hz)
	Output Frequency Resolution	0.01 Hz
	Frequency Setting	0 to +10VDC (20k Ω), 4-20mA (250 Ω)
	Accel/Decel Time	0.0 to 3600.0 sec. (Accel/Decel time setting independently: 0.1 sec)
	Braking Torque	Approx. 20%
	No. of V-f Patterns	1 preset V/f pattern and 1 custom pattern
Protective Functions	Motor Overload Protection	Electronic thermal overload relay (I ² T)
	Instantaneous Overcurrent	Motor coasts to stop at approx. 200% rated output current.
	Fuse Protection	Motor coasts to stop at blown fuse.
	Overload	Motor coasts to stop after 1 min. at rated overload capacity.
	Overvoltage	Motor coasts to a stop if converter output voltage exceeds 410VDC (820VDC at 460V input)
	Undervoltage	Motor coasts to stop if converter output voltage drops below user adjustable value
	Momentary Power Loss	Immediate stop after 15 ms or longer power loss. (Continuous system operation during power loss less than 2 sec is equipped as standard.)
	Heatsink Overheat	Thermistor - OH1, OH2
	Stall Prevention	Stall prevention at acceleration/deceleration and constant speed operation
	Ground Fault	Provided by electronic circuit
	Power Charge Indication	Charge LED stays on until voltage drops below 50VDC
	Input Phase Loss	Single-phase protection
Environmental Conditions	Location	Indoor (protected from corrosive gases and dust)
	Ambient Temperature	+14 to 104° F (-10 to 40° C) for NEMA 1 type (not frozen) +14 to 113° F (-10 to 45° C) for open chassis type
	Storage Temperature	-4 to 140° F (-20 to 60° C)
	Humidity	95% RH (non-condensing)
	Vibration	9.8m/s ² (1G) less than 20Hz, up to 1.96m/s ² (0.2G) at 20 to 50Hz

VS-616P5

Inverter Model CIMR-P5U		VS-616P5											
		2018	2022	2030	2037	2045	2055	2075					
Output Characteristics	Motor Output (HP) *	30	40	50	60	75	100	125					
	Capacity (kVA)	30	37	50	61	70	85	110					
	Rated Output Current (A) - VT **	80	104	130	160	192	248	312					
	Rated Output Current (A) - CT **	64	83	104	128	154	198	250					
	Max. Voltage	3-Phase, 200/208/220/230V (Proportional to input voltage)											
	Rated Output Frequency	0.1 to 400 Hz											
	Overload Capacity - VT **	120% Rated Output Current / 1 minute											
	Overload Capacity - CT **	150% Rated Output Current / 1 minute											
Power Supply	Input Current (A)	88	119	143	176	212	270	344					
	Rated Voltage & Frequency	3-Phase 220 - 230V, 50/60Hz											
	Voltage Fluctuation	+10%, -15%											
	Frequency Fluctuation	±5%											
CIMR-P5U		4018	4022	4030	4037	4045	4055	4075	4110	4160	4185	4220	4300
Output Characteristics	Motor Output (HP) *	30	40	50	60	75	100	150	200	250	300	400	500
	Capacity (kVA)	31	40	50	61	73	98	130	170	230	260	340	460
	Rated Output Current (A) - VT **	41	52	65	80	96	128	180	240	302	380	506	675
	Rated Output Current (A) - CT **	32	42	52	64	77	102	144	182	242	304	404	540
	Max. Voltage #	3-Phase, 380/400/415/440/460V (Proportional to input voltage)											
	Rated Output Frequency	0.1 to 400 Hz											
	Overload Capacity - VT **	120% Rated Current / 1 minute											
	Overload Capacity - CT **	150% Rated Current / 1 minute											
Power Supply	Input Current (A)	46	58	72	88	106	141	198	264	330	456	608	810
	Rated Voltage & Frequency #	3-Phase 380 -440 - 460V, 50/60Hz											
	Voltage Fluctuation	+10%, -15%											
	Frequency Fluctuation	±5%											

* HP ratings based on standard NEMA 4-pole motor data.

For 380V operation, the motor rated current must be less than or equal to the inverter rated current.

** VT: Variable Torque rating (n116=1), CT: Constant Torque rating (n116=0)

Note: Shaded areas indicate factory settings.

Chapter 1 - Receiving & Installation

Specifications

Control Characteristics	Control Method	Sine wave PWM with full-range, automatic torque boost
	Frequency Control Range	0.1 to 400 Hz
	Frequency Accuracy	Digital command: 0.01%, Analog command: 0.1%
	Frequency Setting Resolution	Digital Operator Reference: 0.1Hz, Analog Reference: 0.06Hz (@60Hz)
	Output Frequency Resolution	0.01 Hz
	Frequency Setting	0 to +10VDC (20k Ω), 4-20mA (250 Ω)
	Accel/Decel Time	0.0 to 3600.0 sec. (Accel/Decel time setting independently: 0.1 sec)
	Braking Torque	Approx. 20%
	No. of V-f Patterns	1 preset V/f pattern and 1 custom pattern
	Protective Functions	Motor Overload Protection
Instantaneous Overcurrent		Motor coasts to stop at approx. 180% rated output current.
Fuse Protection		Motor coasts to stop at blown fuse.
Overload		Motor coasts to stop after 1 min. at rated overload capacity.
Overvoltage		Motor coasts to stop if converter output voltage exceeds 410VDC (820VDC at 460V input)
Undervoltage		Motor coasts to stop if converter output voltage drops below user adjustable value
Momentary Power Loss		Immediately stop after 15 ms or longer power loss. (Continuous system operation during power loss less than 2 sec is equipped as standard.)
Heatsink Overheat		Thermistor - OH1, OH2
Stall Prevention		Stall prevention at acceleration/deceleration and constant speed operation
Ground Fault		Provided by electronic circuit
Power Charge Indication		Charge LED stays on until voltage drops below 50VDC
Input Phase Loss	Single-phase protection	
Environmental Conditions	Location	Indoor (protected from corrosive gases and dust)
	Ambient Temperature	+14 to 104°F (-10 to 40°C) for NEMA 1 type (not frozen) +14 to 113°F (-10 to 45°C) for open chassis type
	Storage Temperature	-4 to 140°F (-20 to 60°C)
	Humidity	95% RH (non-condensing)
	Vibration	9.8m/s ² (1G) less than 20Hz, up to 1.96m/s ² (0.2G) at 20 to 50Hz

1.3 PRELIMINARY INSPECTION

Receiving

After unpacking the VS-616PC5/P5:

- Verify that the part numbers on the drive nameplate match the numbers on your purchase order or packing slip.
- Check the unit for physical damage which may have occurred during shipping. If any part of the drive is missing or damaged, notify the carrier and your Yaskawa representative immediately.
- Verify that all internal hardware (i.e. components, screws, etc.) is seated properly and fastened securely.
- Verify that the instruction manual is included (YEA-TOA-S616-12).
- If the drive will be stored after receiving, place it in its original packaging and store according to temperature specifications on page 8.

Checking the Nameplate

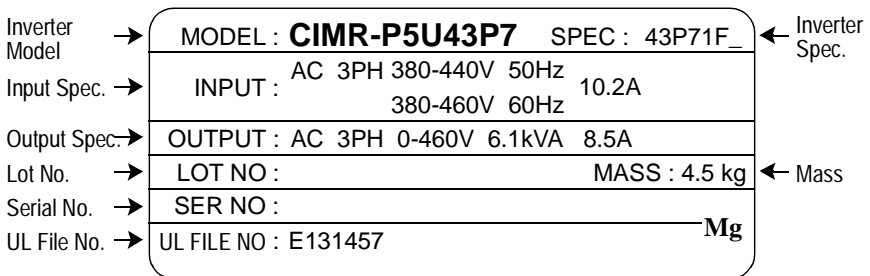

Figure 1 Nameplate Example of American Model CIMR-P5U43P7

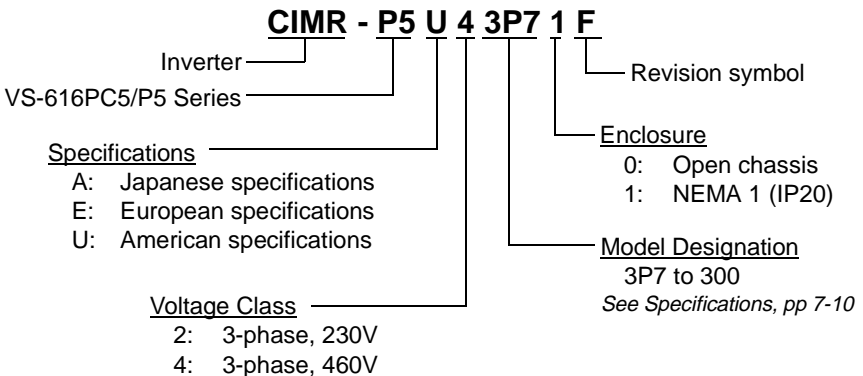

Figure 2 Nameplate Description

Identifying the Parts

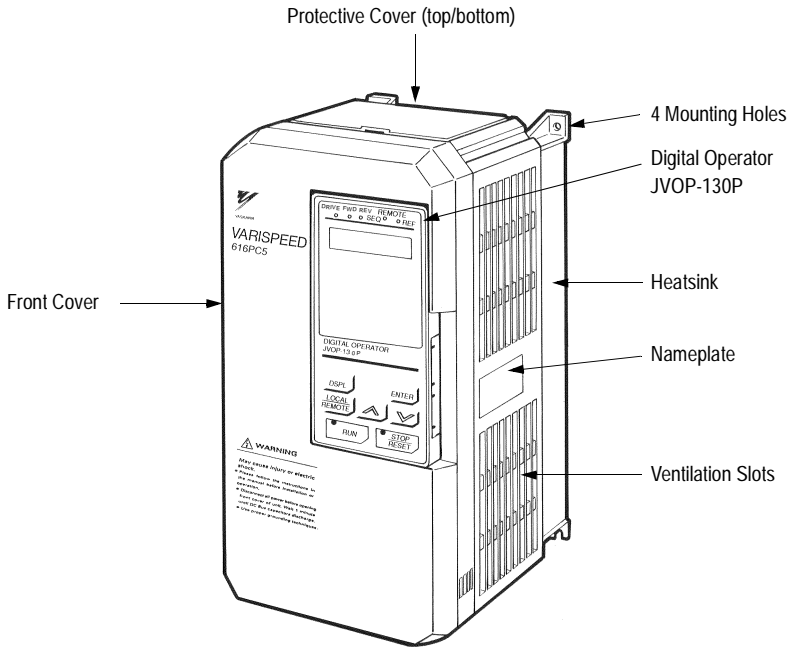

Figure 3 Parts Identification - Model CIMR-P5U43P7

1.4 MOUNTING

CAUTION

PRECAUTIONS

- 1) When preparing to mount the VS-616PC5/P5, lift it by its base. Never lift it by the front cover.
- 2) Mount the inverter onto nonflammable material.
- 3) The VS-616PC5/P5 generates heat. For the most effective cooling possible, mount it vertically. For more details, refer to “Dimensions/Heat Loss” on pages 15 & 16 and “Clearances” on page 17.
- 4) When mounting units in an enclosure, install a fan or other cooling device to keep the intake air temperature below 113°F (45°C).

Failure to observe these precautions may result in equipment damage.

Choosing a Location

Be sure that the inverter is mounted in a location protected against the following conditions:

- Extreme cold and heat. Use only within the ambient temperature range: 14 to 104°F (-10 to 40°C).
- Direct sunlight (not for use outdoors)
- Rain, moisture
- High humidity
- Oil sprays, splashes
- Salt spray
- Dust or metallic particles in the air
- Corrosive gases (e.g. sulfurized gas) or liquids
- Radioactive substances
- Combustibles (e.g. thinner, solvents, etc.)
- Physical shock, vibration
- Magnetic noise (e.g. welding machines, power devices, etc.)

Removing and Replacing the Digital Operator

To remove the digital operator from the front cover, push the operator lever in the direction shown by arrow 1 and lift the digital operator in the direction shown by arrow 2 (see Figure 4).

To replace the digital operator, engage the operator onto retaining tabs A in the direction shown by arrow 1 and then onto retaining tabs B in the direction shown by arrow 2, locking the digital operator into place (see Figure 5).

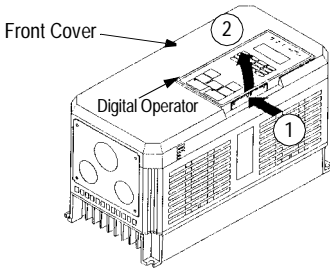

Figure 4 Removing the Digital Operator

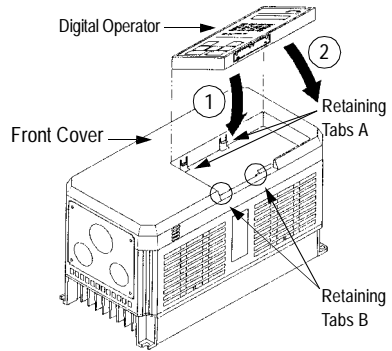

Figure 5 Replacing the Digital Operator

Removing and Replacing the Front Cover

To remove the front cover, first remove the digital operator (see previous section). Then squeeze the cover on both sides in the direction shown by arrows 2 and lift the cover in the direction shown by arrow 3.

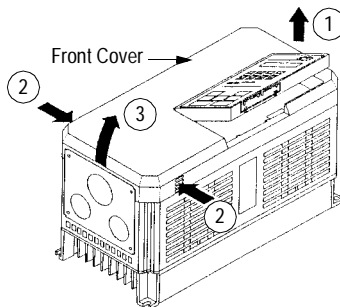

Figure 6 Removing and Replacing the Front Cover

Dimensions/Heat Loss

Open Chassis Type (IP00)

Voltage	Model CIMR -P5U	Open Chassis Dimensions in inches (mm)						Mass lbs (kg)	Heat Loss (W)			
		W	H	D	W1	H1	H2		Heat sink	Inside unit	Total	
230V	20P4								15	50	65	
	20P7	5.51 (140)	11.02 (280)	6.30 (160)	4.96 (126)	10.47 (266)	0.28 (7)	6.5 (3)	25	65	90	
	21P5								40	80	120	
	22P2	5.51 (140)	11.02 (280)	7.09 (180)	4.96 (126)	10.47 (266)	0.28 (7)	10 (4.5)	80	60	140	
	23P7								135	80	215	
	25P5	7.87 (200)	11.81 (300)	8.07 (205)	7.32 (186)	11.22 (285)	0.31 (8)	12 (5.5)	210	90	300	
	27P5								13 (6)	235	110	345
	2011	9.84 (250)	14.96 (380)	8.86 (225)	9.29 (236)	14.37 (365)	0.30 (7.5)	24 (11)	425	160	585	
	2015								525	200	725	
	2018	12.80 (325)	17.72 (450)	11.22 (285)	10.83 (275)	17.13 (435)	0.30 (7.5)	62 (28)	655	230	885	
	2022								830	280	1110	
	2030	16.73 (425)	26.57 (675)	13.78 (350)	12.60 (320)	25.59 (650)	0.49 (12.5)	134 (61)	1050	500	1550	
	2037								137 (62)	1250	700	1950
	2045	18.70 (475)	31.50 (800)	13.78 (350)	14.57 (370)	30.51 (775)	0.49 (12.5)	176 (80)	1550	750	2300	
	2055								1950	1000	2950	
2075	22.64 (575)	36.42 (925)	15.75 (400)	17.52 (445)	35.24 (895)	0.59 (15)	298 (135)	2300	1300	3600		
460V	40P4							6.5 (3)	10	50	60	
	40P7	5.51 (140)	11.02 (280)	6.30 (160)	4.96 (126)	10.47 (266)	0.28 (7)		20	65	85	
	41P5							8.8 (4)	30	80	110	
	42P2								65	60	125	
	43P7	5.51 (140)	11.02 (280)	7.09 (180)	4.96 (126)	10.47 (266)	0.28 (7)	10 (4.5)	80	65	145	
	44P0								120	80	200	
	45P5	7.87 (200)	11.81 (300)	8.07 (205)	7.32 (186)	11.22 (285)	0.31 (8)	13 (6)	135	85	220	
	47P5								240	120	360	
	4011	9.84 (250)	14.96 (380)	8.86 (225)	9.29 (236)	14.37 (365)	0.30 (7.5)	24 (11)	305	150	455	
	4015								390	180	570	
	4018	12.80 (325)	17.72 (450)	11.22 (285)	10.83 (275)	17.13 (435)	0.30 (7.5)	60 (27)	465	195	660	
	4022								620	260	880	
	4030								705	315	1020	
	4037	12.80 (325)	24.61 (625)	11.22 (285)	10.83 (275)	24.02 (610)	0.30 (7.5)	97 (44)	875	370	1245	
	4045								970	415	1385	
	4055								174 (79)	1110	710	1820
	4075	17.91 (455)	32.28 (820)	13.78 (350)	13.78 (350)	31.30 (795)	0.49 (12.5)	176 (80)	1430	890	2320	
	4110	22.64 (575)	36.42 (925)	14.76 (375)	17.52 (445)	35.24 (895)	0.59 (15)	298 (135)	1870	1160	3030	
	4160			15.75 (400)				320 (145)	2670	1520	4190	
	4185	37.40 (950)	57.09 (1450)	17.13 (435)	29.53 (750)	55.12 (1400)	0.98 (25)	794 (360)	3400	1510	4910	
4220								4740	2110	6850		
4300	37.80 (960)	62.99 (1600)	17.91 (455)	29.53 (750)	61.02 (1550)	0.98 (25)	926 (420)	6820	2910	9730		

Chapter 1 - Receiving & Installation

Mounting

Enclosed Type (NEMA 1, IP20)

Voltage	Model (CIMR- P5U)	NEMA 1 Dimensions in inches (mm)						Mass lbs (kg)
		W	H	D	W1	H1	H2	
230V	20P4	5.51 (140)	11.02 (280)	6.30 (160)	4.96 (126)	10.47 (266)	0.28 (7)	6.5 (3)
	20P7							
	21P5							
	22P2	5.51 (140)	11.02 (280)	7.09 (180)	4.96 (126)	10.47 (266)	0.28 (7)	10 (4.5)
	23P7							
	25P5	7.87 (200)	11.81 (300)	8.07 (205)	7.32 (186)	11.22 (285)	0.31 (8)	12 (5.5)
	27P5							13 (6)
	2011	9.84 (250)	14.96 (380)	8.86 (225)	9.29 (236)	14.37 (365)	0.30 (7.5)	24 (11)
	2015		15.75 (400)				1.08 (27.5)	
	2018	12.99 (330)	24.02 (610)	11.22 (285)	10.83 (275)	17.13 (435)	3.44 (87.5)	71 (32)
	2022		26.57 (675)				6.00 (152.5)	
	2030	16.93 (430)	38.78 (985)	13.78 (350)	12.60 (320)	25.59 (650)	8.37 (212.5)	148 (67)
	2037							150 (68)
	2045	18.90 (480)	43.70 (1110)	13.78 (350)	14.57 (370)	30.51 (775)	8.37 (212.5)	192 (87)
2055								
2075	22.83 (580)	50.79 (1290)	15.75 (400)	17.52 (445)	35.24 (895)	10.63 (270)	320 (145)	
460V	40P4	5.51 (140)	11.02 (280)	6.30 (160)	4.96 (126)	10.47 (266)	0.28 (7)	6.5 (3)
	40P7							
	41P5							8.8 (4)
	42P2	5.51 (140)	11.02 (280)	7.09 (180)	4.96 (126)	10.47 (266)	0.28 (7)	10 (4.5)
	43P7							
	44P0	7.87 (200)	11.81 (300)	8.07 (205)	7.32 (186)	11.22 (285)	0.31 (8)	13 (6)
	45P5							
	47P5	9.84 (250)	14.96 (380)	8.86 (225)	9.29 (236)	14.37 (365)	0.30 (7.5)	24 (11)
	4011							
	4015	12.99 (330)	24.02 (610)	11.22 (285)	10.83 (275)	17.13 (435)	3.44 (87.5)	68 (31)
	4018							
	4022	12.99 (330)	30.91 (785)	11.22 (285)	10.83 (275)	24.02 (610)	3.44 (87.5)	106 (48)
	4030		33.46 (850)				6.00 (152.5)	
	4037	18.11 (460)	44.49 (1130)	13.78 (350)	13.78 (350)	31.30 (795)	8.37 (212.5)	187 (85)
4045	190 (86)							
4055	22.83 (580)	50.79 (1290)	14.76 (375)	17.52 (445)	35.24 (895)	10.63 (270)	320 (145)	
4075			15.75 (400)				342 (155)	
4110	22.83 (580)	50.79 (1290)	14.76 (375)	17.52 (445)	35.24 (895)	10.63 (270)	320 (145)	
4160			15.75 (400)				342 (155)	

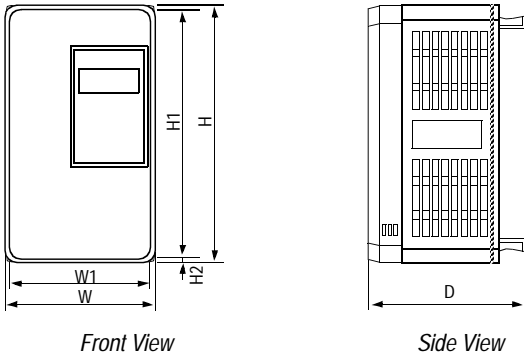

Figure 7 VS-616PC5/P5 Dimension Diagram

Clearances

When mounting the VS-616PC5/P5, allow sufficient clearances for effective cooling as shown below:

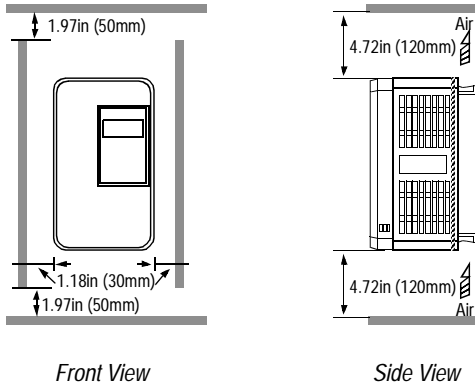

Figure 8 VS-616PC5/P5 Clearances

Notes:

- 1) The required clearances at the top, bottom, and both sides of the inverter are the same for both open chassis and NEMA 1 enclosures.
- 2) For inverter models 25HP and less (230V & 460V), remove the top and bottom covers to convert NEMA 1 units to open chassis
- 3) Allowable intake air temperature:
 Open chassis: 14°F to 113°F (-10°C to +45°C)
 NEMA 1: 14°F to 104°F (-10°C to 40°C)
- 4) When mounting units in an enclosure, install a fan or other cooling device to limit the air temperature within the inverter to below 113°F (45°C).

1.5 WIRING

CAUTION

PRECAUTIONS

- 1) Do not connect or disconnect wiring, or perform signal checks while the power supply is turned ON.
- 2) Connect the power supply wiring to terminals L1, L2 and L3 on the main circuit input section. DO NOT connect the power supply wiring to output terminals T1, T2 and T3.
- 3) Connect the motor wiring to terminals T1, T2 and T3 on the main circuit output section.
- 4) *Never* touch the output circuit directly or place the output line in contact with the inverter enclosure.
- 5) Do not connect a phase-advancing capacitor or an LC/RC noise filter to the output circuit.
- 6) The motor wiring must be less than 328ft (100m) in length and in a separate conduit from the input power wiring.
- 7) Control wiring must be less than 164ft (50m) in length and in a separate conduit from both the motor wiring and the power wiring.
- 8) Tighten the screws on the main circuit and control circuit terminals.
- 9) Low voltage wires shall be wired with Class 1 wiring.
- 10) Please observe national electrical code (NEC) when wiring electrical devices.

Failure to observe these precautions may result in equipment damage.

Inspection

After wiring is complete, verify that:

All wiring is correctly installed.

Excess screws and wire clippings are removed from inside of the unit.

Screws are securely tightened.

Exposed wire has no contact with other wiring or terminals.

VS-616PC5 Standard Connection Diagram

230V: Models 20P4 through 27P5
460V: Models 40P4 through 40I5

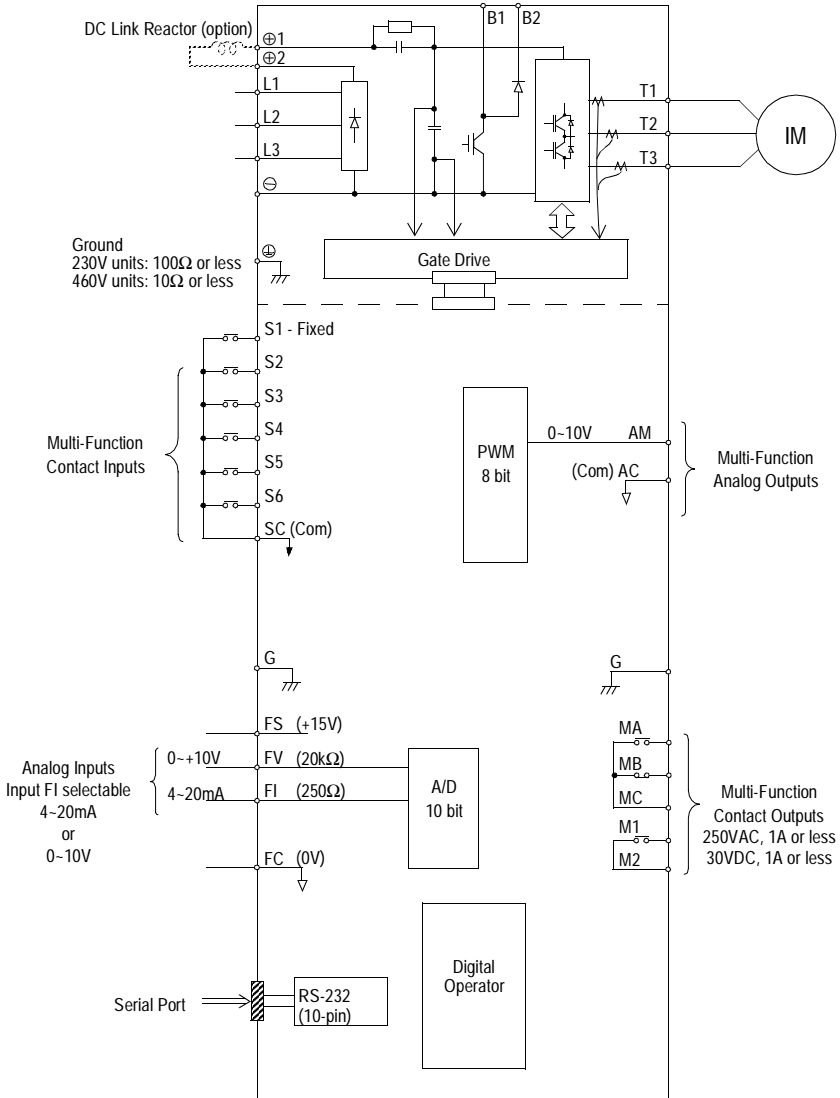

Figure 9 VS-616PC5 Terminal Diagram

VS-616P5 Standard Connection Diagram

230V: Models 2018 through 2075
 460V: Models 4018 through 4160

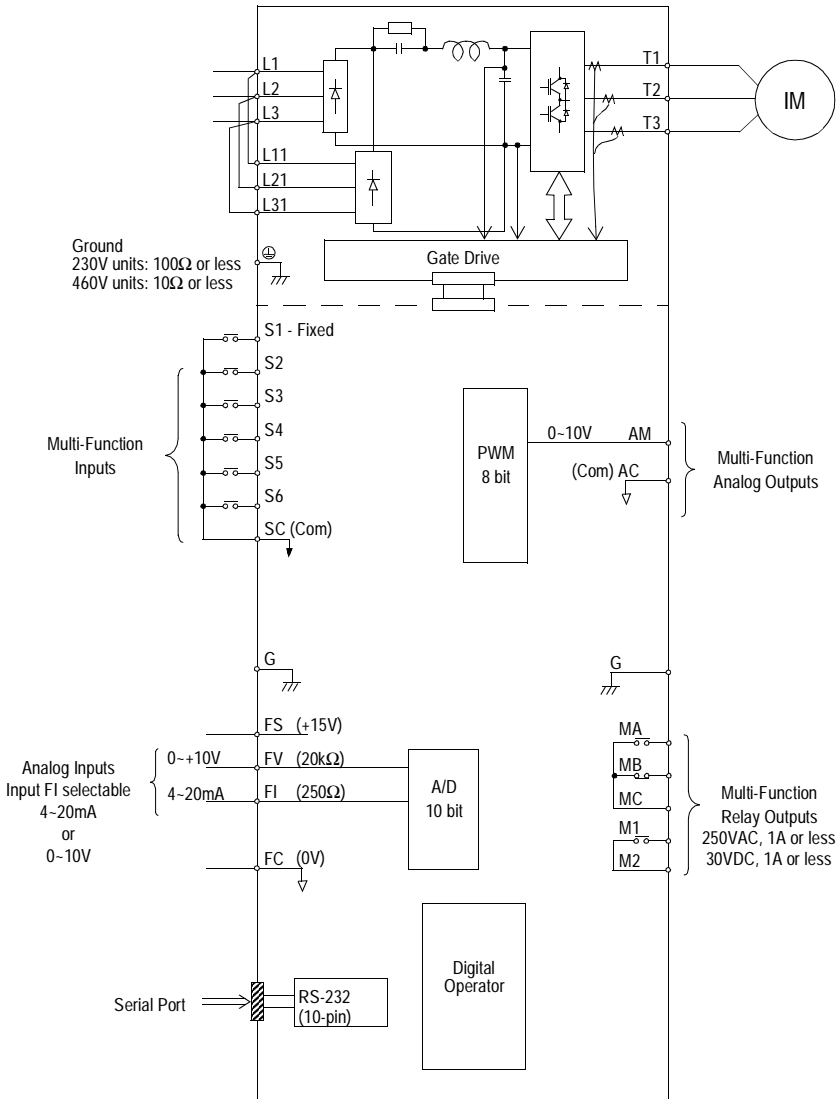

Figure 10 VS-616P5 Terminal Diagram

Main Circuit Wiring

Input Wiring

- Molded-Case Circuit Breaker (MCCB)

Be sure to connect MCCBs or fuses between the AC main circuit power supply and VS-616PC5/P5 input terminals L1, L2 and L3, to protect the power supply wiring.

- Ground Fault Interrupter

When connecting a ground fault interrupter to input terminals L1, L2 and L3, select one that is not affected by high frequency.

Examples: NV series by Mitsubishi Electric Co., Ltd. (manufactured in or after 1988), EGSG series by Fuji Electric Co., Ltd. (manufactured in or after 1984).

- Magnetic Contactor (MC)

Inverters can be used without an MC installed on the power supply side. An MC can be used instead of an MCCB to apply the main circuit power supply. However, when an MC is switched OFF on the primary side, dynamic braking does not function and the motor coasts to stop.

The load can be operated/stopped by closing/opening the MC on the primary side. However, frequent switching may cause the inverter to malfunction.

When using a braking resistor unit, use an MC to break the power supply side of the inverter in the event of a dynamic braking overload relay trip. Otherwise, if the inverter malfunctions, the braking resistor unit may be burned out.

- Terminal Block Connection Sequence

Input power supply phases can be connected to any terminal regardless of the order of L1, L2 and L3 on the terminal block.

- AC Reactor

When connecting an inverter (230V/460V, 25HP or less) to a large capacity power supply transformer (600kVA or more), or when switching a phase-advancing capacitor, excessive peak current flows through the input power supply circuit, which may damage the converter section. In such cases, install a DC reactor (optional) between inverter ⊕1 and ⊕2 terminals, or an AC reactor (optional) on the input side. Installation of a reactor is also effective for improving power factor on the power supply side.

· Surge Suppressor

For inductive loads (i.e. magnetic contactors, magnetic relays, magnetic valves, solenoids, magnetic brakes, etc.) connected near the inverter, use a surge suppressor across the coils to limit the transients on the supply lines.

Output Wiring

· Motor Connection

Connect motor lead wires to output terminals T1, T2 and T3. Verify that the motor rotates in the forward direction (CCW: counterclockwise when viewed from the motor load side) with the forward run command. If the motor rotation is incorrect, exchange any two of the motor leads.

· Magnetic Starter

Do not connect a magnetic starter or a magnetic contactor to the output circuit. If the motor load is connected or disconnected while the inverter is running, the inverter overcurrent protective circuitry may trip.

· Thermal Overload Relay

An electronic overload protective function (I^2t) is incorporated into the inverter. However, when driving several motors with one inverter, or when switching between multiple windings of a multiple winding motor, use an external thermal overload relay(s). In this case, set parameter *n034* to “Disabled”.

· Wiring Distance Between Inverter and Motor

If the total wiring distance between inverter and motor is excessively long and the inverter carrier frequency (IGBT switching frequency) is high, harmonic leakage current from the wiring will adversely affect the inverter and peripheral devices. If the wiring distance is long, reduce the inverter carrier frequency as described below. Carrier frequency can be set by parameter *n054*.

Wiring Distance Between Inverter and Motor

Wiring Distance between Inverter and Motor	Up to 164 ft. (50m)	Up to 328 ft. (100m)	More than 328 ft. (100m)
Carrier Frequency * (Set value of parameter <i>n054</i>)	15kHz or less (6)	10kHz or less (4)	5kHz or less (2)

* Increasing the carrier frequency above the factory default value requires current derating. Contact your Yaskawa representative for details.

Grounding

- Ground Resistance

230V class: 100Ω or less, 460V class: 10Ω or less.

- Never ground the VS-616PC5/P5 in common with welding machines, motors, or other high-current electrical equipment. Run all ground wiring in a separate conduit.
- Use ground wiring as specified in “Wire and Terminal Screw Sizes” on page 25, and keep the length as short as possible.
- When using several VS-616PC5/P5 units side by side, ground the units as shown in Figure 10, (a) or (b). Do not loop the wires as shown in (c).

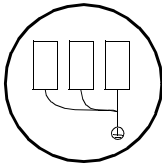

(a) *Acceptable*

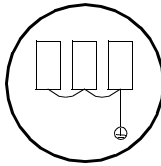

(b) *Acceptable*

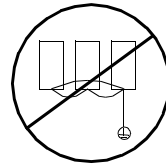

(c) *Not Acceptable*

Figure 11 *Grounding Example of 3 VS-616P5 Inverters*

Terminal Functions

230V Class Terminal Functions

Model CIMR-P5U	20P4 to 27P5	2011 to 2015	2018 to 2075
Nominal Motor Output	0.5 to 10HP	20 to 25HP	30 to 125HP
L1	Main circuit input power supply	---	Main circuit input power supply
L2			
L3			
L11			
L21			
L31			
T1	Inverter output		
T2			
T3			
B1	Braking resistor unit	---	
B2			
⊖	DC reactor (⊕1 - ⊕2) DC power supply (⊕1 - ⊖)	DC reactor (⊕1 - ⊕2) DC power supply (⊕1 - ⊖) Braking unit (⊕3 - ⊖)	---
⊕1			
⊕2			
⊕3			
⊕	Ground terminal (Ground resistance: 100Ω or less)		

460V Class Terminal Functions

Model CIMR-P5U	40P4 to 4015	4018 to 4045	4055 to 4160	4185 to 4300
Nominal Motor Output	0.5 to 25HP	30 to 75HP	100 to 250HP	300 to 500HP
L1	Main circuit input power supply	Main circuit input power supply	Main circuit input power supply	Main circuit input power supply
L2				
L3				
L11				
L21				
L31				
T1	Inverter output			
T2				
T3				
B1	Braking resistor unit	---		
B2				
⊖	DC reactor (⊕1 - ⊕2) DC power supply (⊕1 - ⊖)	---		
⊕1				
⊕2				
r		---		Cooling fan power supply (Control power supply) r - s 200: 200 to 230 VAC input r - s 400: 380 to 460 VAC input
s 200				
s 400				
⊕	Ground terminal (Ground resistance: 10Ω or less)			

Wire and Terminal Screw Sizes

230V Class Wire Size

Circuit	Model CIMR-	Terminal Symbol	Terminal Screw	Wire Size *		Max. Torque lb-in (N·m)	Wire Type		
				AWG	mm ²				
Main	P5U20P4	L1, L2, L3, ⊕1, ⊕2, B1, B2, T1, T2, T3 ⊕	M4	14 - 10	2 - 5.5	12.4 (1.4)	Power cable: 600V vinyl sheathed wire or equivalent		
	P5U20P7	L1, L2, L3, ⊕1, ⊕2, B1, B2, T1, T2, T3 ⊕	M4	14 - 10	2 - 5.5	12.4 (1.4)			
	P5U21P5	L1, L2, L3, ⊕1, ⊕2, B1, B2, T1, T2, T3 ⊕	M4	14 - 10 12 - 10	2 - 5.5 3.5 - 5.5	12.4 (1.4)			
	P5U22P2	L1, L2, L3, ⊕1, ⊕2, B1, B2, T1, T2, T3 ⊕	M4	12 - 10	3.5 - 5.5	12.4 (1.4)			
	P5U23P7	L1, L2, L3, ⊕1, ⊕2, B1, B2, T1, T2, T3 ⊕	M4	10	5.5	12.4 (1.4)			
	P5U25P5	L1, L2, L3, ⊕1, ⊕2, B1, B2, T1, T2, T3 ⊕	M5	8 10 - 8	8 5.5 - 8	22.1 (2.5)			
	P5U27P5	L1, L2, L3, ⊕1, ⊕2, B1, B2, T1, T2, T3 ⊕	M5	8 10 - 8	8 5.5 - 8	22.1 (2.5)			
	P5U2011	L1, L2, L3, ⊕1, ⊕2, ⊕3, T1, T2, T3 ⊕	M6	4 8	22 8	45.1 (5.1)			
	P5U2015	L1, L2, L3, ⊕1, ⊕2, ⊕3, T1, T2, T3 ⊕	M8 M6	3 8	30 8	90.3 (10.2) 45.1 (5.1)			
	P5U2018	L1, L2, L3, L11, L21, L31, T1, T2, T3 ⊕	M8	3 6	30 14	90.3 (10.2)			
	P5U2022	L1, L2, L3, L11, L21, L31, T1, T2, T3 ⊕	M8	2 6	38 14	90.3 (10.2)			
	P5U2030	L1, L2, L3, L11, L21, L31, T1, T2, T3 ⊕	M10 M8	4/0 4	100 22	203.6 (23.0) 90.3 (10.2)			
	P5U2037	L1, L2, L3, L11, L21, L31, T1, T2, T3 ⊕	M10 M8	1/0 x 2P 4	60 x 2P 22	203.6 (23.0) 90.3 (10.2)			
	P5U2045	L1, L2, L3, L11, L21, L31, T1, T2, T3 ⊕	M10 M8	1/0 x 2P 4	60 x 2P 22	203.6 (23.0) 90.3 (10.2)			
	P5U2055	L1, L2, L3, L11, L21, L31, T1, T2, T3 ⊕	M10 M8	1/0 x 2P 3	60 x 2P 30	203.6 (23.0) 90.3 (10.2)			
	P5U2075	L1, L2, L3, L11, L21, L31, T1, T2, T3 ⊕	M12 M8	4/0 x 2P 1	100 x 2P 50	349.6 (39.5) 90.3 (10.2)			
	Control	Common to all models	S1, S2, S3, S4, S5, S6, SC FV, FI, FS, FC AM, AC, M1, M2, MA, MB, MC	-	20 - 16	Stranded 0.5 - 1.25		-	Twisted shielded wire with Class 1 wiring
			G	M3.5		20 - 14			

* Wire sizes are based on 75°C copper wire.

Note:

Voltage drop should be considered when determining wire size. Voltage drop can be calculated using the following equation:

$$\text{Phase-to phase voltage drop (V)} = \sqrt{3} \text{ wire resistance } (\Omega/\text{km}) \times \text{wiring distance (m)} \times \text{current (A)} \times 10^{-3}$$

Select a wire size so that voltage drop will be less than 2% of the normal rated voltage.

Chapter 1 - Receiving & Installation

Wiring

460V Class Wire Size

Circuit	Model CIMR-	Terminal Symbol	Terminal Screw	Wire Size *		Max. Torque lb-in (N-m)	Wire Type
				AWG	mm ²		
Main	P5U40P4	L1, L2, L3, ⊖, ⊕1, ⊕2, B1, B2, T1, T2, T3	M4	14 - 10	2 - 5.5	12.4 (1.4)	Power cable: 600V vinyl sheathed wire or equivalent
		⊕		14 - 10	2 - 5.5		
	P5U40P7	L1, L2, L3, ⊖, ⊕1, ⊕2, B1, B2, T1, T2, T3	M4	12 - 10	3.5 - 5.5	12.4 (1.4)	
		⊕		14 - 10	2 - 5.5		
	P5U41P5	L1, L2, L3, ⊖, ⊕1, ⊕2, B1, B2, T1, T2, T3	M4	12 - 10	3.5 - 5.5	12.4 (1.4)	
		⊕		14 - 10	2 - 5.5		
	P5U42P2	L1, L2, L3, ⊖, ⊕1, ⊕2, B1, B2, T1, T2, T3	M4	12 - 10	3.5 - 5.5	12.4 (1.4)	
		⊕		14 - 10	2 - 5.5		
	P5U43P7	L1, L2, L3, ⊖, ⊕1, ⊕2, B1, B2, T1, T2, T3	M4	12 - 10	3.5 - 5.5	12.4 (1.4)	
		⊕		12 - 10	3.5 - 5.5		
	P5U45P5	L1, L2, L3, ⊖, ⊕1, ⊕2, B1, B2, T1, T2, T3	M4	12 - 10	3.5 - 5.5	12.4 (1.4)	
		⊕		12 - 10	3.5 - 5.5		
	P5U47P5	L1, L2, L3, ⊖, ⊕1, ⊕2, B1, B2, T1, T2, T3	M5	8 - 6	8 - 14	22.1 (2.5)	
		⊕		8 - 6	8 - 14		
	P5U4011	L1, L2, L3, ⊖, ⊕1, ⊕2, B1, B2, T1, T2, T3	M5	8 - 6	8 - 14	22.1 (2.5)	
		⊕		8 - 6	8 - 14		
	P5U4015	L1, L2, L3, ⊖, ⊕1, ⊕2, B1, B2, T1, T2, T3	M5	8 - 6	8 - 14	22.1 (2.5)	
		⊕		8 - 6	8 - 14		
	P5U4018	L1, L2, L3, L11, L21, L31, T1, T2, T3	M6	6	14	45.1 (5.1)	
		⊕		8 - 6	8 - 14		
	P5U4022	L1, L2, L3, L11, L21, L31, T1, T2, T3	M6	4	22	45.1 (5.1)	
		⊕		4	22		
	P5U4030	L1, L2, L3, L11, L21, L31, T1, T2, T3	M8	4	22	90.3 (10.2)	
		⊕		4	22		
	P5U4037	L1, L2, L3, L11, L21, L31, T1, T2, T3	M8	3	30	90.3 (10.2)	
		⊕		4	22		
	P5U4045	L1, L2, L3, L11, L21, L31, T1, T2, T3	M8	1	50	90.3 (10.2)	
		⊕		3	30		
	P5U4055	L1, L2, L3, L11, L21, L31, T1, T2, T3	M10	4/0	100	203.6 (23.0)	
		⊕		M8	1		
P5U4075	L1, L2, L3, L11, L21, L31, T1, T2, T3	M10	1/0 x 2P	60 x 2P	203.6 (23.0)		
	⊕		M8	1/0		60	
P5U4110	L1, L2, L3, L11, L21, L31, T1, T2, T3	M10	1/0 x 2P	60 x 2P	203.6 (23.0)		
	⊕		M8	1/0		60	
P5U4160	L1, L2, L3, L11, L21, L31, T1, T2, T3	M12	4/0 x 2P	100 x 2P	349.6 (39.5)		
	⊕		M8	4/0		100	
P5U4185	L1, L2, L3, ⊖, ⊕1, ⊕3, T1, T2, T3	M16	650MCM x 2P	325 x 2P	867.4 (98.0)		
	⊕		M8	650MCM		325	
	r, s200, s400		M4	20 - 10		0.5 - 5.5	
P5U4220	L1, L2, L3, ⊖, ⊕1, ⊕3, T1, T2, T3	M16	650MCM x 2P	325 x 2P	867.4 (98.0)		
	⊕		M8	650MCM		325	
	r, s200, s400		M4	20 - 10		0.5 - 5.5	
P5U4300	L1, L2, L3, ⊖, ⊕1, ⊕3, T1, T2, T3	M16	650MCM x 2P	325 x 2P	867.4 (98.0)		
	⊕		M8	650MCM		325	
	r, s200, s400		M4	20 - 10		0.5 - 5.5	
Control	Common to all models	S1, S2, S3, S4, S5, S6, SC FV, FI, FS, FC AM, AC, M1, M2, MA, MB, MC	-	20 - 16	Stranded 0.5 - 1.25 Solid 0.5 - 1.25	-	Twisted shielded wire with Class 1 wiring
		G	M3.5	20 - 14	0.5 - 2	8.9 (1.0)	

* Wire sizes are based on 75°C copper wire.

JST Closed Loop Connectors

Wire Size *		Terminal Screw	JST Closed-Loop Connectors (Lugs)	Max. Torque lb-in (N-m)
AWG	mm ²			
20	0.5	M3.5	1.25 - 3.5	8.9 (1.0)
		M4	1.25 - 4	12.4 (1.4)
18	0.75	M3.5	1.25 - 3.5	8.9 (1.0)
		M4	1.25 - 4	12.4 (1.4)
16	1.25	M3.5	1.25 - 3.5	8.9 (1.0)
		M4	1.25 - 4	12.4 (1.4)
14	2	M3.5	2 - 3.5	8.9 (1.0)
		M4	2 - 4	12.4 (1.4)
		M5	2 - 5	22.1 (2.5)
		M6	2 - 6	45.1 (5.1)
		M8	2 - 8	90.3 (10.2)
12 - 10	3.5 - 5.5	M4	5.5 - 4	12.4 (1.4)
		M5	5.5 - 5	22.1 (2.5)
		M6	5.5 - 6	45.1 (5.1)
		M8	5.5 - 8	90.3 (10.2)
8	8	M5	8 - 5	22.1 (2.5)
		M6	8 - 6	45.1 (5.1)
		M8	8 - 8	90.3 (10.2)
6	14	M6	14 - 6	45.1 (5.1)
		M8	14 - 8	90.3 (10.2)
4	22	M6	22 - 6	45.1 (5.1)
		M8	22 - 8	90.3 (10.2)
3 - 2	30 - 38	M8	38 - 8	90.3 (10.2)
1 - 1/0	50 - 60	M8	60 - 8	90.3 (10.2)
		M10	60 - 10	203.6 (23.0)
3/0	80	M10	80 - 10	203.6 (23.0)
4/0	100		100 - 10	203.6 (23.0)
4/0	100	M12	100 - 12	349.6 (39.5)
300MCM	150		150 - 12	349.6 (39.5)
400MCM	200		200 - 12	349.6 (39.5)
650MCM	325	M12 x 2	325 - 12	349.6 (39.5)
		M16	325 - 16	867.4 (98.0)

Note:

The use of a JST closed-loop connector (lug) is recommended to maintain proper clearances. Please contact your Yaskawa representative for more information.

Control Circuit Wiring

The following table outlines the functions of the control circuit terminals.

Control Circuit Terminals

Classification	Terminal	Function	Description	Signal Level	
Multi-function Input Signal	S1	Forward run/stop	Forward run when closed, stop when open	Photo-coupler insulation Input: +24VDC 8mA	
	S2	Reverse run/stop	Reverse run when closed, stop when open		
	S3	External fault input	Fault when closed, normal state when open		
	S4	Fault reset input	Reset when closed		
	S5	Multi-step speed reference 1	Enabled when closed		
	S6	Multi-step speed reference 2	Enabled when closed		
	SC	Sequence input common terminal	—		
Analog Input Signal	FS	+15V Power supply output	For analog command +15V power supply	+15V (allowable current 20mA max.)	
	FV	Frequency reference input (voltage)	0 to +10V/100%	n043 = "FV=MSTR": FV enabled 0 to +10V (20kΩ)	
	FI	Frequency reference input (current)	4 to 20mA/100%	n043 = "FI=MSTR": FI enabled 4 to 20mA (250Ω)	
	FC	Common terminal	0V	—	
	G	Connection to shield sheath of signal lead	—	—	
Multi-function Output Signal	M1	During running (N.O. contact)	Closed when running	Multi-function contact output (n042)	Dry contact Contact capacity: 250VAC 1A or less 30VDC 1A or less
	M2				
	MA	Fault contact output (N.O./N.C. contact)	Fault when closed between terminals MA and MC Fault when open between terminals MB and MC	Multi-function contact output (n041)	
	MB				
	MC				
Analog Output Signal	AM	Frequency meter output	0 to +10V/100% frequency	Multi-function analog monitor 1 (n052)	0 to +10V 2mA or less
	AC	Common			

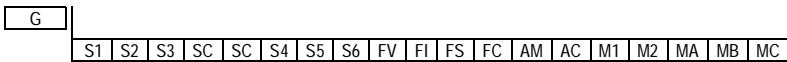

Figure 12 Control Circuit Terminal Arrangement

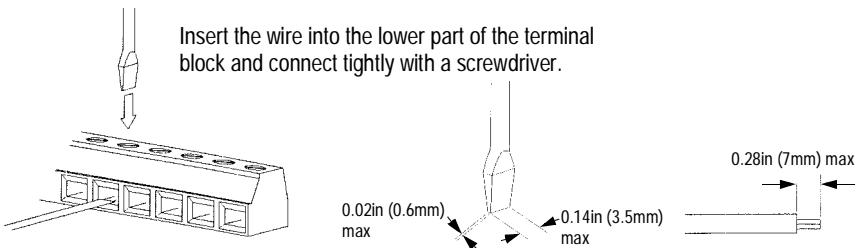

Figure 13 Wiring the Control Circuit Terminal

- CHAPTER 2 -

OPERATION

<u>Section</u>	<u>Description</u>	<u>Page</u>
2	OPERATION	
	Precautions	30
2.1	TRIAL OPERATION	31
	Digital Operator Display at Power-up	31
	Operation Checkpoints	32
	Basic Operation	32
2.2	DIGITAL OPERATOR DISPLAY	35
2.3	LED DESCRIPTION	36
2.4	OPERATION MODE SELECTION	37

WARNING

PRECAUTIONS

- 1) Only turn ON the input power supply after replacing the front cover. Do not remove the cover while the inverter is powered up.
- 2) When the retry function (*n060*) is selected, do not approach the inverter or the load, since it may restart suddenly after being stopped.
- 3) Since the Stop key can be disabled by a function setting, install a separate emergency stop switch to disconnect power or fault the inverter.
- 4) Do not touch the heatsink or braking resistor, due to very high temperatures.
- 5) Since it is very easy to change operation speed from low to high speed, verify the safe working range of the motor and machine before operation.
- 6) Install a separate holding brake, if necessary.
- 7) Do not check signals during operation.
- 8) All inverter parameters have been preset at the factory. Do not change the settings without thorough review of the possible consequences.

Failure to observe these precautions may result in equipment damage, serious personal injury, or death.

2.1 TRIAL OPERATION

To ensure safety, prior to initial operation, disconnect the machine coupling so that the motor is isolated from the machine. If initial operation must be performed while the motor is still coupled to the machine, use great care to avoid potentially hazardous conditions. Check the following items before a trial run:

- Wiring and terminal connections are proper.
- Wire clippings and other debris removed from the unit.
- Screws are securely tightened.
- Motor is securely mounted.
- All items are correctly grounded.

Digital Operator Display at Power-Up (JVOP-130P)

When the system is ready for operation, turn ON the power supply. Verify that the inverter powers up properly. If any problems are detected, turn OFF the power supply immediately. The digital operator display illuminates as shown below when the power supply is turned ON.

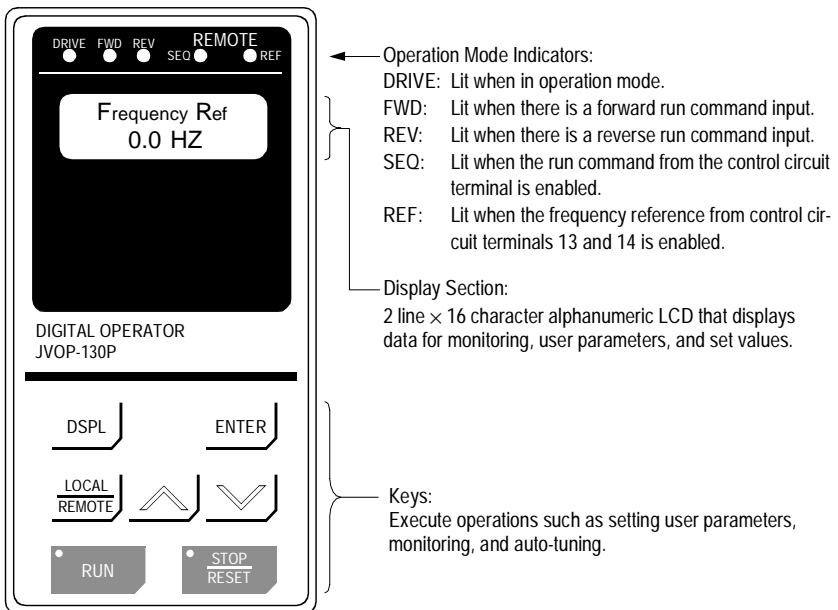

Figure 14 *Digital Operator Display at Power-up (JVOP-130P)*

Operation Checkpoints:

- Motor rotates smoothly.
- Motor rotates in the correct direction.
- Motor has no abnormal vibration and is not noisy.
- Acceleration and deceleration are smooth.
- Unit is not overloaded.
- Status indicator LEDs and digital operator display are correct.

Basic Operation

The inverter will operate after receiving a frequency reference. There are two operation modes for the VS-616PC5/P5:

- Run command from the digital operator.
- Run command from the control circuit terminals.

Operation by Digital Operator

The diagram below shows a typical operation pattern using the digital operator. Pressing the LOCAL/REMOTE key once while the inverter is stopped places the inverter in the LOCAL mode. The digital operator, JVOP-130P, can then be used to start and stop and change the reference.

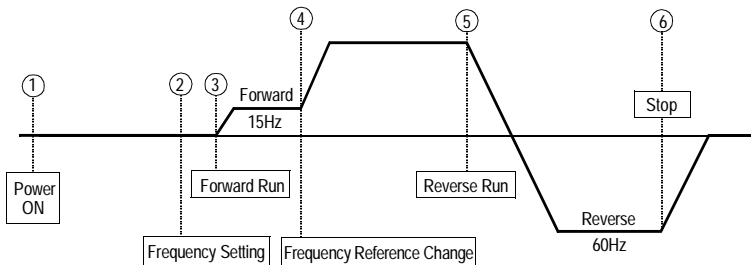

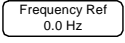
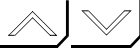

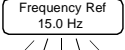
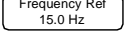
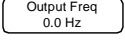

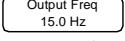

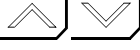

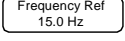
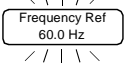
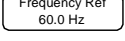
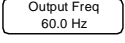

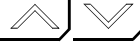

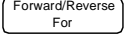
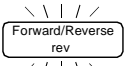
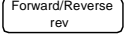
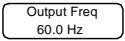

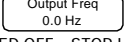

Figure 15 Operation Sequence by Digital Operator

Typical Operation Example by Digital Operator (JVOP-130P)

Description	Key Sequence	Digital Operator Display
<p>(1) Power ON</p> <ul style="list-style-type: none"> Displays frequency reference value. <p>↓</p> <p>Operation Condition Setting</p> <ul style="list-style-type: none"> Select LOCAL mode. <p>↓</p>	<p style="text-align: center;"></p>	<p>REMOTE LED (SEQ, REF) ON</p> <p style="text-align: center;"></p> <p>REMOTE LED (SEQ, REF) OFF</p>
<p>(2) Frequency Setting</p> <ul style="list-style-type: none"> Change frequency reference value. <p>↓</p> <ul style="list-style-type: none"> Write-in set value. <p>↓</p> <ul style="list-style-type: none"> Select output frequency monitor display. 	<p>Change the value by depressing</p> <p style="text-align: center;"></p> <p style="text-align: center;"></p> <p style="text-align: center;"></p>	<p style="text-align: center;"></p> <p style="text-align: center;"></p> <p style="text-align: center;"></p>
<p>(3) Forward Run</p> <ul style="list-style-type: none"> Forward run (15Hz) <p>↓</p>	<p style="text-align: center;"></p>	<p style="text-align: center;"></p> <p>RUN LED ON</p>
<p>(4) Frequency Reference Value Change (15~60Hz)</p> <ul style="list-style-type: none"> Select frequency reference value display. <p>↓</p> <ul style="list-style-type: none"> Change set value. <p>↓</p> <ul style="list-style-type: none"> Write-in set value. <p>↓</p> <ul style="list-style-type: none"> Select output frequency monitor display. 	<p style="text-align: center;"></p> <p>Depress 15 times</p> <p>Change the value by depressing</p> <p style="text-align: center;"></p> <p style="text-align: center;"></p> <p style="text-align: center;"></p>	<p style="text-align: center;"></p> <p style="text-align: center;"></p> <p style="text-align: center;"></p> <p style="text-align: center;"></p>
<p>(5) Reverse Run</p> <ul style="list-style-type: none"> Select reverse run. <p>↓</p> <ul style="list-style-type: none"> Write-in set value. <p>↓</p> <ul style="list-style-type: none"> Select output frequency monitor display. 	<p style="text-align: center;"></p> <p>Depress 3 times.</p> <p>Switch to "rev" by depressing</p> <p style="text-align: center;"></p> <p style="text-align: center;"></p> <p style="text-align: center;"></p> <p>Depress 13 times.</p>	<p style="text-align: center;"></p> <p style="text-align: center;"></p> <p>REVERSE LED (REV) ON</p> <p style="text-align: center;"></p> <p style="text-align: center;"></p>
<p>(6) Stop</p> <ul style="list-style-type: none"> Decelerates to stop. 	<p style="text-align: center;"></p>	<p style="text-align: center;"></p> <p>RUN LED OFF STOP LED ON</p>

Operation by Control Circuit Terminal Signal

The diagram below shows a typical operation pattern using the control circuit terminal signals.

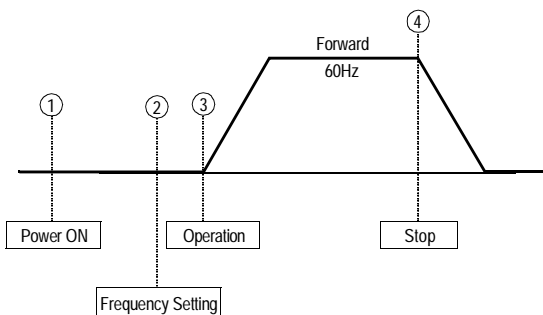

Figure 16 Operation Sequence by Control Circuit Terminal Signal

Typical Operation Example by Control Circuit Terminal Signal

Description	Key Sequence	Digital Operator Display
<p>(1) Power ON</p> <ul style="list-style-type: none"> Displays frequency reference value. REMOTE mode is preset at the factory. 		<div style="border: 1px solid black; padding: 2px; width: fit-content; margin: 5px auto;">Frequency Ref 0.0 Hz</div> <p>REMOTE LED (SEQ, REF) ON</p>
<p>(2) Frequency Setting</p> <ul style="list-style-type: none"> Input frequency reference voltage (current) by control circuit terminal FV or FI and verify the input value by the digital operator. <p>Output Frequency Display</p> <ul style="list-style-type: none"> Write-in set value. 	<p>DSPL</p>	<div style="border: 1px solid black; padding: 2px; width: fit-content; margin: 5px auto;">Frequency Ref 60.0 Hz</div> <p>For reference voltage 10V</p>
<p>(3) Forward Run</p> <ul style="list-style-type: none"> Close between control circuit terminals S1 and SC to perform forward run. 		<div style="border: 1px solid black; padding: 2px; width: fit-content; margin: 5px auto;">Output Freq 60.0 Hz</div> <p>RUN LED ON</p>
<p>(4) Stop</p> <ul style="list-style-type: none"> Open between control circuit terminals S1 and SC to stop operation. 		<div style="border: 1px solid black; padding: 2px; width: fit-content; margin: 5px auto;">Output Freq 0.0 Hz</div> <p>STOP LED ON (RUN LED blinking during deceleration)</p>

2.2 DIGITAL OPERATOR DISPLAY

All functions of the VS-616PC5/P5 are accessed using the JVOP-130P Digital Operator. Below are descriptions of the display and keypad sections.

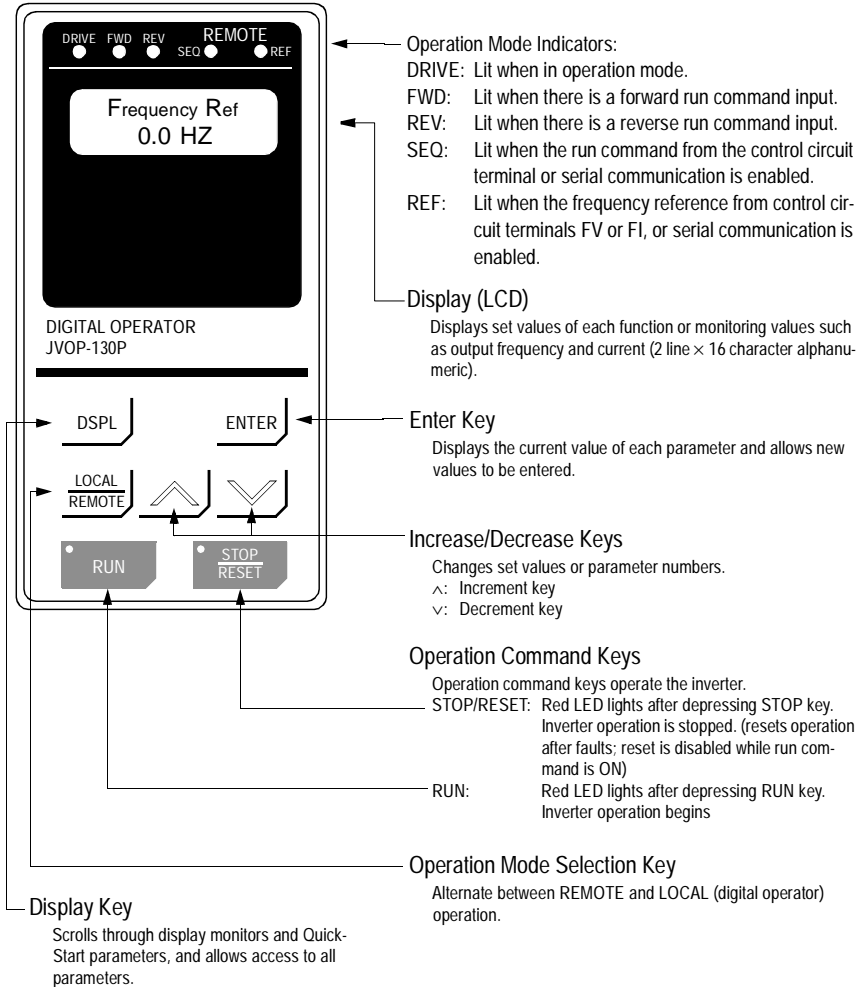

Figure 17 Digital Operator Display at Power-up

2.3 LED DESCRIPTION

Simple operation of the VS-616PC5/P5 is possible, by using the quick-start displays.

Quick-Start Displays (Example of CIMR-P5U23P7)

Description	Key Sequence	Digital Operator Display	Remarks
Power ON			
Frequency reference setting/monitoring	DSPL	Frequency Ref 0.0 Hz	Depress [ENTER] key to display the monitor value. Set/read is enabled only during stop. Depress [ENTER] key to display data.
Output frequency monitor	DSPL	Output Freq 0.0 Hz	
Output current monitor	DSPL	Output Amps 0.0 A	
Output power monitor	DSPL	Output Power 0.0 kW	
FWD/REV run command selection	DSPL	Forward/Reverse For	
Monitor selection	DSPL	Monitor U-01 Frequency Ref	
Acceleration time	DSPL	Accel Time 1 10.0 Sec	
Deceleration time	DSPL	Decel Time 1 10.0 Sec	
Input voltage	DSPL	Input Voltage 230.0 VAC	
V/f pattern selection	DSPL	V/f Selection 60Hz Preset	
Frequency reference gain	DSPL	Terminal FV Gain 100%	
Frequency reference bias	DSPL	Terminal FV Bias 0%	
Motor rated current	DSPL	Motor rated FLA 19.6A	
PID selection	DSPL	PID Mode Disabled	
Energy saving selection	DSPL	Energy Sav Sel Disabled	
Parameter Number/data	DSPL	Parameter n002 Oper Mode Select	

2.4 OPERATION MODE SELECTION (*n002, Oper Mode Select*)

The VS-616PC5/P5 has two operation modes: LOCAL and REMOTE (see table below for description). These two modes can be selected by the digital operator “LOCAL/REMOTE” key only when operation is stopped. The operation mode selected can be verified by observing the SEQ and REF LEDs on the digital operator (as shown below). The operation mode is set to REMOTE (run by control circuit terminals FV and FI frequency reference and run command from control circuit terminals) prior to shipment. Multi-function contact inputs from control circuit terminals S3 to S6 are enabled in both operation modes.

- LOCAL: Both frequency reference and run command are set by the digital operator. Remote SEQ and REF LEDs go OFF.
- REMOTE: Master frequency reference and run command can be selected as described in the table below.

Parameter n111, LOC/REM Change, will determine if the inverter will acknowledge a previously closed run input during a switchover from LOCAL to REMOTE mode.

- When n111 is set to “Cycle Extern Run”, the inverter will not start if the run input is closed during the transition from LOCAL to REMOTE.
- When n111 is set to “Accept Extern Run”, the inverter will immediately start if the run input is closed during the transition from LOCAL to REMOTE.

Operation Mode Selection

LED Display	LCD Display	Operation Method Selection	SEQ LED	Reference Selection	REF LED
0	SEQ=OPR REF=OPR	Operation by run command from digital operator	OFF	Master frequency reference from digital operator	OFF
1	SEQ=TRM REF=OPR	Operation by run command from control circuit terminal	ON	Master frequency reference from digital operator	OFF
2	SEQ=OPR REF=TRM	Operation by run command from digital operator	OFF	Master frequency reference from control circuit terminals FV and FI	ON
3	SEQ=TRM REF=TRM	Operation by run command from control circuit terminal	ON	Master frequency reference from control circuit terminals FV and FI	ON
4	SEQ=OPR REF=COM	Operation by run command from digital operator	OFF	Master frequency reference set by serial communication	ON
5	SEQ=TRM REF=COM	Operation by run command from control circuit terminal	ON	Master frequency reference set by serial communication	ON
6	SEQ=COM REF=COM	Operation by run command from serial communication	ON	Master frequency reference set by serial communication	ON
7	SEQ=COM REF=OPR	Operation by run command from serial communication	ON	Master frequency reference from digital operator	OFF

LED Display	LCD Display	Operation Method Selection	SEQ LED	Reference Selection	REF LED
8	SEQ=COM REF=TRM	Operation by run command from serial communication	ON	Master frequency reference from control circuit terminals FV and FI	ON

- CHAPTER 3 -

PROGRAMMING FEATURES

<u>Section</u>	<u>Description</u>	<u>Page</u>
3	PROGRAMMING FEATURES	
3.1	VS-616PC5/P5 PARAMETERS (<i>n001~n116</i>)	41
3.2	PARAMETER SET-UP & INITIALIZATION	49
3.3	VS-616PC5/P5 OPERATION	50
	Accel/decel time adjustment	50
	Automatic fault retry	51
	Automatic restart after momentary power loss	51
	Carrier frequency	51
	Current limit (Stall prevention)	52
	DC injection braking	54
	Energy savings control	55
	Frequency agree set point	57
	Frequency meter or ammeter	58
	Frequency meter or ammeter calibration	58
	Frequency signal adjustment	58
	Jog operation	60

	Jump frequencies	60
	MODBUS communication	61
	Motor overload detection	62
	Multi-step speed selection	64
	Phase loss detection	65
	PID Control	66
	Reverse run prohibit	68
	Soft-start characteristics	68
	Speed limit adjustment	69
	Stopping method	70
	Torque adjustment	72
	Torque detection	73
	Tripless operation	74
	V/f pattern adjustment	75
	Slip compensation	77
3.4	INPUTS & OUTPUTS	78
	Multi-function input signals	78
	Analog input signals	82
	Multi-function output signals	83

3.1 VS-616PC5/P5 Parameters (n001~n116)

No.	Function Name (LCD Operator Display)	Description	Factory Default	User Setting	Ref. Page																																							
n001	Parameter selection/ initialization (Password)	0: n001 read and set, n002~n116 read only 1: n001~n035 read and set, n036~n116 read only 2: n001~n053 read & set, n054~n116 read only 3: n001~n116 read and set 4, 5: Not used 6: 2-wire initialization (Japanese specifications) 7: 3-wire initialization (Japanese specifications) 8: 2-wire initialization (American specifications) 9: 3-wire initialization (American specifications)	1		49																																							
n002	Operation mode selection (Oper Mode Select)	<table border="1"> <thead> <tr> <th>LED Setting</th> <th>LCD Setting</th> <th>Operation</th> <th>Reference</th> </tr> </thead> <tbody> <tr> <td>0</td> <td>SEQ=OPR REF=OPR</td> <td>Operator</td> <td>Operator</td> </tr> <tr> <td>1</td> <td>SEQ=TRM REF=OPR</td> <td>Terminal</td> <td>Operator</td> </tr> <tr> <td>2</td> <td>SEQ=OPR REF=TRM</td> <td>Operator</td> <td>Terminal</td> </tr> <tr> <td>3</td> <td>SEQ=TRM REF=TRM</td> <td>Terminal</td> <td>Terminal</td> </tr> <tr> <td>4</td> <td>SEQ=OPR REF=COM</td> <td>Operator</td> <td>Serial com</td> </tr> <tr> <td>5</td> <td>SEQ=TRM REF=COM</td> <td>Terminal</td> <td>Serial com</td> </tr> <tr> <td>6</td> <td>SEQ=COM REF=COM</td> <td>Serial com</td> <td>Serial com</td> </tr> <tr> <td>7</td> <td>SEQ=COM REF=OPR</td> <td>Serial com</td> <td>Operator</td> </tr> <tr> <td>8</td> <td>SEQ=COM REF=TRM</td> <td>Serial com</td> <td>Terminal</td> </tr> </tbody> </table>	LED Setting	LCD Setting	Operation	Reference	0	SEQ=OPR REF=OPR	Operator	Operator	1	SEQ=TRM REF=OPR	Terminal	Operator	2	SEQ=OPR REF=TRM	Operator	Terminal	3	SEQ=TRM REF=TRM	Terminal	Terminal	4	SEQ=OPR REF=COM	Operator	Serial com	5	SEQ=TRM REF=COM	Terminal	Serial com	6	SEQ=COM REF=COM	Serial com	Serial com	7	SEQ=COM REF=OPR	Serial com	Operator	8	SEQ=COM REF=TRM	Serial com	Terminal	SEQ=TRM REF=TRM	37
LED Setting	LCD Setting	Operation	Reference																																									
0	SEQ=OPR REF=OPR	Operator	Operator																																									
1	SEQ=TRM REF=OPR	Terminal	Operator																																									
2	SEQ=OPR REF=TRM	Operator	Terminal																																									
3	SEQ=TRM REF=TRM	Terminal	Terminal																																									
4	SEQ=OPR REF=COM	Operator	Serial com																																									
5	SEQ=TRM REF=COM	Terminal	Serial com																																									
6	SEQ=COM REF=COM	Serial com	Serial com																																									
7	SEQ=COM REF=OPR	Serial com	Operator																																									
8	SEQ=COM REF=TRM	Serial com	Terminal																																									
n003	Input voltage (Input Voltage)	Unit: 0.1V Setting range: 150.0~255.0V (510V for 460V units)	230.0V (460.0V)		-																																							
n004	Stopping method (Stopping Method)	<table border="1"> <thead> <tr> <th>LED Setting</th> <th>LCD Setting</th> <th>Description</th> </tr> </thead> <tbody> <tr> <td>0</td> <td>Ramp to stop</td> <td>Ramp to stop</td> </tr> <tr> <td>1</td> <td>Coast to stop</td> <td>Coast to stop</td> </tr> <tr> <td>2</td> <td>Coast w/Timer1</td> <td>Coast to stop with timer (Run command cycle)</td> </tr> <tr> <td>3</td> <td>Coast w/Timer2</td> <td>Coast to stop with timer (auto-start after time out)</td> </tr> </tbody> </table>	LED Setting	LCD Setting	Description	0	Ramp to stop	Ramp to stop	1	Coast to stop	Coast to stop	2	Coast w/Timer1	Coast to stop with timer (Run command cycle)	3	Coast w/Timer2	Coast to stop with timer (auto-start after time out)	Ramp to Stop	70																									
LED Setting	LCD Setting	Description																																										
0	Ramp to stop	Ramp to stop																																										
1	Coast to stop	Coast to stop																																										
2	Coast w/Timer1	Coast to stop with timer (Run command cycle)																																										
3	Coast w/Timer2	Coast to stop with timer (auto-start after time out)																																										
n005	Motor rotation (Motor Rotation)	<table border="1"> <thead> <tr> <th>LED Setting</th> <th>LCD Setting</th> <th>Description</th> </tr> </thead> <tbody> <tr> <td>0</td> <td>Rotate C.C.W.</td> <td>CCW shaft rotation</td> </tr> <tr> <td>1</td> <td>Rotate C.W.</td> <td>CW shaft rotation</td> </tr> </tbody> </table>	LED Setting	LCD Setting	Description	0	Rotate C.C.W.	CCW shaft rotation	1	Rotate C.W.	CW shaft rotation	Rotate C.C.W.	-																															
LED Setting	LCD Setting	Description																																										
0	Rotate C.C.W.	CCW shaft rotation																																										
1	Rotate C.W.	CW shaft rotation																																										
n006	Prohibit reverse operation (Reverse Oper)	<table border="1"> <thead> <tr> <th>LED Setting</th> <th>LCD Setting</th> <th>Description</th> </tr> </thead> <tbody> <tr> <td>0</td> <td>Rev Allowed</td> <td>Reverse operation enabled</td> </tr> <tr> <td>1</td> <td>Rev Prohibited</td> <td>Reverse operation disabled</td> </tr> </tbody> </table>	LED Setting	LCD Setting	Description	0	Rev Allowed	Reverse operation enabled	1	Rev Prohibited	Reverse operation disabled	Rev Allowed	68																															
LED Setting	LCD Setting	Description																																										
0	Rev Allowed	Reverse operation enabled																																										
1	Rev Prohibited	Reverse operation disabled																																										
n007	Local/remote key function (Local/Remote Key)	<table border="1"> <thead> <tr> <th>LED Setting</th> <th>LCD Setting</th> </tr> </thead> <tbody> <tr> <td>0</td> <td>Disabled</td> </tr> <tr> <td>1</td> <td>Enabled</td> </tr> </tbody> </table>	LED Setting	LCD Setting	0	Disabled	1	Enabled	Enabled	37																																		
LED Setting	LCD Setting																																											
0	Disabled																																											
1	Enabled																																											
n008	Stop key function (Oper STOP Key)	<table border="1"> <thead> <tr> <th>LED Setting</th> <th>LCD Setting</th> <th>Description</th> </tr> </thead> <tbody> <tr> <td>0</td> <td>Disabled</td> <td>Stop key is disabled when operated from terminals</td> </tr> <tr> <td>1</td> <td>Enabled</td> <td>Stop key is always enabled</td> </tr> </tbody> </table>	LED Setting	LCD Setting	Description	0	Disabled	Stop key is disabled when operated from terminals	1	Enabled	Stop key is always enabled	Enabled	-																															
LED Setting	LCD Setting	Description																																										
0	Disabled	Stop key is disabled when operated from terminals																																										
1	Enabled	Stop key is always enabled																																										
n009	Frequency reference set- ting method from operator (Operator MOP)	<table border="1"> <thead> <tr> <th>LED Setting</th> <th>LCD Setting</th> </tr> </thead> <tbody> <tr> <td>0</td> <td>Enter not used</td> </tr> <tr> <td>1</td> <td>Enter key used</td> </tr> </tbody> </table>	LED Setting	LCD Setting	0	Enter not used	1	Enter key used	Enter key used	-																																		
LED Setting	LCD Setting																																											
0	Enter not used																																											
1	Enter key used																																											
n010	V/f pattern selection (V/f Selection)	<table border="1"> <thead> <tr> <th>LED Setting</th> <th>LCD Setting</th> <th>Description</th> </tr> </thead> <tbody> <tr> <td>0</td> <td>User Defined V/f</td> <td>Custom V/f pattern (n011 ~ n017 can be set)</td> </tr> <tr> <td>1</td> <td>60 Hz Preset</td> <td>Fixed V/f pattern</td> </tr> </tbody> </table>	LED Setting	LCD Setting	Description	0	User Defined V/f	Custom V/f pattern (n011 ~ n017 can be set)	1	60 Hz Preset	Fixed V/f pattern	60 Hz Preset	75,96																															
LED Setting	LCD Setting	Description																																										
0	User Defined V/f	Custom V/f pattern (n011 ~ n017 can be set)																																										
1	60 Hz Preset	Fixed V/f pattern																																										
n011	Maximum frequency (Max Frequency)	Unit: 0.1Hz Setting range: 50.0~400.0Hz	60.0Hz		76																																							
n012	Maximum voltage (Max Voltage)	Unit: 0.1V Setting range: 0.1~255.0V (510V for 460V units)	230.0V		76																																							
n013	Base frequency (Base Frequency)	Unit: 0.1Hz Setting range: 0.2~400.0Hz	60.0Hz		76																																							

No.	Function Name (LCD Operator Display)	Description	Factory Default	User Setting	Ref. Page
n014	Mid. output frequency (Mid Frequency)	Unit: 0.1Hz Setting range: 0.1-399.9Hz	3Hz		76
n015	Mid. frequency voltage (Mid Voltage)	Unit: 0.1V Setting range: 0.1-255.0V (510V for 460V units)	17.2V (34.4V)		76
n016	Minimum output frequency (Min Frequency)	Unit: 0.1Hz Setting range: 0.1-10.0Hz	1.5Hz		76
n017	Minimum output voltage (Min Voltage)	Unit: 0.1V Setting range: 0.1-50.0V (510V for 460V units)	11.5V (23.0V)		76
n018	Acceleration time 1 (Accel Time 1)	Unit: 0.1s (1s for 1000s and above) Setting range: 0.0-3600s	10.0s		50,96
n019	Deceleration time 1 (Decel Time 1)	Unit: 0.1s (1s for 1000s and above) Setting range: 0.0-3600s	10.0s		50,96
n020	Acceleration time 2 (Accel Time 2)	Unit: 1s Setting range: 0-255s	10.0s		50
n021	Deceleration time 2 (Decel Time 2)	Unit: 1s Setting range: 0-255s	10.0s		50
n022	S-curve selection (S-Curve Select)	<u>LED Setting</u> <u>LCD Setting</u> 0 No S-curve 1 0.2s 2 0.5s 3 1.0s	0.2s		68
n023	Display mode (Display Units)	<u>Setting</u> <u>Display</u> 0 0.1Hz 1 0.1% 2-39 rpm (input # of motor poles) 40-3999 custom	0		-
n024	Frequency reference 1 (Reference 1)	Setting depends on n023 setting. Range: 0-9999	0.0Hz		64,95
n025	Frequency reference 2 (Reference 2)	Setting depends on n023 setting. Range: 0-9999	0.0Hz		64
n026	Frequency reference 3 (Reference 3)	Setting depends on n023 setting. Range: 0-9999	0.0Hz		64
n027	Frequency reference 4 (Reference 4)	Setting depends on n023 setting. Range: 0-9999	0.0Hz		64
n028	Not used	-	-	-	-
n029	Not used	-	-	-	-
n030	Jog frequency (Jog Reference)	Setting depends on n023 setting. Range: 0-9999	6.0Hz		60
n031	Frequency upper limit (Ref Upper Limit)	Unit: 1% Setting range: 0-109%	100%		69
n032	Frequency lower limit (Ref Lower Limit)	Unit: 1% Setting range: 0-100%	0%		69
n033	Motor rated current (Motor Rated FLA)	Unit: 0.1A Range: 10-200% inverter rated current Unit is 1A, when setting is more than 1,000A	kVA dependent		62,96

No.	Function Name (LCD Operator Display)	Description			Factory Default	User Setting	Ref. Page
n034	Motor thermal protection (Motor OL Sel)	<u>LED Setting</u>	<u>LCD Setting</u>	<u>Description</u>	STD Motor/ 8 min		62
		0	Disabled	Protection disabled			
		1	STD Motor/8 min	General-purpose motor (time constant 8 min.)			
		2	STD Motor/5 min	General-purpose motor (time constant 5 min.)			
		3	INV Motor/8 min	Blower-cooled motor (time constant 8 min.)			
4	INV Motor/ 5 min	Blower-cooled motor (time constant 5 min.)					
n035	Stop method selection - OH1- for inverter overheat pre-alarm (OH1 Stop Method)	<u>LED Setting</u>	<u>LCD Setting</u>	<u>Description</u>	Continue Oper		-
		0	Ramp STOP/Decel 1	Ramp to stop - Decel 1 (fault)			
		1	Coast to STOP	Coast to stop (fault)			
		2	Ramp STOP/Decel 2	Ramp to stop - Decel 2 (fault)			
		3	Continue Oper	Continue operation (alarm) at 80% of frequency reference			
n036	Multi-function input selection 1 (Terminal S2 Sel)	<u>LED Setting</u>	<u>LCD Setting</u>	<u>Description</u>	Reverse RUN (2W)		78
		0	Reverse RUN (2W)	Reverse run (2-wire sequence)			
		1	FWD/REV Cmd (3W)	Fwd / Rev command (3-wire sequence)			
		2	Ext Fault (NO)	External fault (normally open)			
		3	Ext Fault (NC)	External fault (normally closed)			
		4	Fault Reset	Fault reset			
		5	LOCAL/REMOTE Sel	Local / Remote selection			
		6	COMINV Sel	Serial com/inverter selection (Fref, RUN command)			
		7	STOP Cmd/Dec2 NO	Fast stop using Decel 2 (normally open)			
		8	STOP Cmd/Dec2 NC	Fast stop using Decel 2 (normally closed)			
		9	Master Fref Sel	Master freq. ref. selection (FV-open or F1-closed)			
		10	Multi-Step Spd 1	Multi-step speed reference command 1			
		11	Multi-Step Spd 2	Multi-step speed reference command 2			
		12	Not Used	Not used			
		13	JOG Command	Jog reference (n030)			
		14	Acc/Dec Switch	Accel / Decel time selection			
		15	Ext Baseblk (NO)	External baseblock (normally open)			
		16	Ext Baseblk (NC)	External baseblock (normally closed)			
		17	SpdSrch (MAXFRQ)	Speed search from maximum frequency			
		18	SpdSrch (SETFRQ)	Speed search from set frequency			
		19	Param Lockout	Parameter setting enable / disable			
		20	PID 1 Reset	PID integral value reset			
		21	PID Disable	PID control enable / disable			
		22	Timer Start Cmd	Timer function			
		23	OH3 Input	External overheat alarm (OH3)			
		24	Ref Sample Hold	Analog reference sample hold command			
		25	KEB Cmd (NO)	Inertia ridthrough command (normally open)			
		26	KEB Cmd (NC)	Inertia ridthrough command (normally closed)			
27	Hold Command	Accel / Decel hold command					
28	PID Polarity Sel	Inverse PID enable / disable					

No.	Function Name (LCD Operator Display)	Description	Factory Default	User Setting	Ref. Page
n037	Multi-function input 2 (Terminal S3 Sel)	Set items are same as n036. (When n036="FWD/REV Cmd (3W)", "In Use By Other" is displayed, and setting is prohibited)	Ext Fault (NO)		78
n038	Multi-function input 3 (Terminal S4 Sel)	Set items are same as n036.	Fault Reset		78
n039	Multi-function input 4 (Terminal S5 Sel)	Set items are same as n036. (When n040="Up/Down Control", "In Use By Other" is displayed, and setting is prohibited)	Multi-Step Spd 1		78
n040	Multi-function input 5 (Terminal S6 Sel)	Set items are same as n036. LED Setting LCD Setting Description 29 Up / Down control Up / Down command (Terminal S5=Up command, and terminal S6=Down command).	Multi-Step Spd 2		78
n041	Multi-function output selection 1 (Terminal MA Sel)	LED Setting LCD Setting Description 0 Fault Fault 1 During Running During running 2 At Speed Frequency agree 3 At Desired Speed Desired frequency agree 4 Freq Detection 1 Frequency detection 1 5 Freq detection 2 Frequency detection 2 6 OverTrq Det (NO) Over/Undertorque detection (normally open) 7 OverTrq Det (NC) Over/Undertorque detection (normally closed) 8 Baseblocked During baseblock 9 Operation Mode Local mode 10 Ready Inverter operation ready 11 Timer Output Timer function 12 Auto-Restarting During auto restart 13 OL Pre-Alarm OL pre-alarm (80% OL1 or OL2) 14 Freq Ref Loss Frequency reference loss 15 Set By COM Cntl Closed by serial communication 16 PID Fdbk Loss PID feedback loss 17 OH1 Alarm OH1 Alarm (set if n035 set to "3")	Fault		83
n042	Multi-function output selection 2 (Terminal M1 Sel)	Set items are as same as n041	During Running		83
n043	Master analog input selection - FV or FI terminal (Analog Input Sel)	LED Setting LCD Setting FV FI Remarks 0 FV=MSTR FI=AUX Master Aux. Enable 1 FV=AUX FI=MSTR Aux. Master Enable 2 FV=RST FI=MSTR Fault reset Master Disable Enable: FV/FI switchover function is enabled. Disable: FV/FI switchover function is disabled. Note: When PID is enabled (n084 ≠ 0), FV terminal = PID reference, and FI terminal = PID feedback.	FV=MSTR FI=AUX		82
n044	Aux. analog input selection (Terminal FI Sel)	LED Setting LCD Setting Description 0 0-10VDC 0-10V input (Jumper J1 must be cut) 1 4-20mA 4-20mA input	4-20mA		82
n045	Frequency reference retention (MOP Ref Memory)	LED Setting LCD Setting Description 0 Memorize Fref Retained in frequency reference 1 (n024) 1 Not Memorized Not retained after power-down	Memorize Fref		82

No.	Function Name (LCD Operator Display)	Description	Factory Default	User Setting	Ref. Page															
n046	Operation method for frequency reference loss detection (Ref Loss Detect)	<table border="1"> <thead> <tr> <th>LED Setting</th> <th>LCD Setting</th> <th>Description</th> </tr> </thead> <tbody> <tr> <td>0</td> <td>Not detected</td> <td>No detection</td> </tr> <tr> <td>1</td> <td>Run @ n047 Fref</td> <td>Continue to run at n047 setting</td> </tr> </tbody> </table>	LED Setting	LCD Setting	Description	0	Not detected	No detection	1	Run @ n047 Fref	Continue to run at n047 setting	Not Detected		82						
LED Setting	LCD Setting	Description																		
0	Not detected	No detection																		
1	Run @ n047 Fref	Continue to run at n047 setting																		
n047	Frequency reference level at loss of Fref (Fref Lvl@F Loss)	Unit: 1% Setting range: 0-100% of setting Fref	80%		82															
n048	Terminal FV gain (Terminal FV Gain)	Unit: 1% Setting range: 0-200%	100%		59,96															
n049	Terminal FV bias (Terminal FV Bias)	Unit: 1% Setting range: -100-100%	0%		59,96															
n050	Terminal FI gain (Terminal FI Gain)	Unit: 1% Setting range: 0-200%	100%		59															
n051	Terminal FI bias (Terminal FI Bias)	Unit: 1% Setting range: -100-100%	0%		59															
n052	Multi-function analog output AM (Terminal AM Sel)	<table border="1"> <thead> <tr> <th>LED Setting</th> <th>LCD Setting</th> <th>Monitor</th> </tr> </thead> <tbody> <tr> <td>0</td> <td>Output Freq</td> <td>Output frequency</td> </tr> <tr> <td>1</td> <td>Output Amps</td> <td>Output current</td> </tr> <tr> <td>2</td> <td>Output kWatts</td> <td>Output power</td> </tr> <tr> <td>3</td> <td>DC Bus Voltage</td> <td>DC bus voltage</td> </tr> </tbody> </table>	LED Setting	LCD Setting	Monitor	0	Output Freq	Output frequency	1	Output Amps	Output current	2	Output kWatts	Output power	3	DC Bus Voltage	DC bus voltage	Output Freq		58
LED Setting	LCD Setting	Monitor																		
0	Output Freq	Output frequency																		
1	Output Amps	Output current																		
2	Output kWatts	Output power																		
3	DC Bus Voltage	DC bus voltage																		
n053	Analog monitor gain (Terminal AM Gain)	Unit: 0.01 Setting range: 0.01-2.00	1.00		58															
n054	Carrier frequency (Carrier Freq Sel)	Unit: 1 Setting range: 1-6 (x2.5kHz), 7-9 (custom pattern)	kVA dependent		51															
n055	Momentary power loss ridethrough method (PwrL Selection)	<table border="1"> <thead> <tr> <th>LED Setting</th> <th>LCD Setting</th> <th>Method</th> </tr> </thead> <tbody> <tr> <td>0</td> <td>Not Provided</td> <td>Not provided</td> </tr> <tr> <td>1</td> <td>2 Seconds Max</td> <td>Continuous operation after power recovery within 2s</td> </tr> <tr> <td>2</td> <td>CPU Power Active</td> <td>Continuous operation after power recovery within control logic time (no fault output)</td> </tr> </tbody> </table>	LED Setting	LCD Setting	Method	0	Not Provided	Not provided	1	2 Seconds Max	Continuous operation after power recovery within 2s	2	CPU Power Active	Continuous operation after power recovery within control logic time (no fault output)	Not Provided		51			
LED Setting	LCD Setting	Method																		
0	Not Provided	Not provided																		
1	2 Seconds Max	Continuous operation after power recovery within 2s																		
2	CPU Power Active	Continuous operation after power recovery within control logic time (no fault output)																		
n056	Speed search level - decel time fixed at 2 sec (SpdSrch Current)	Unit: 1% Setting range: 0-200% 100% = inverter rated current	110%		74															
n057	Minimum baseblock time (Min Baseblock t)	Unit: 0.1s Setting range: 0.5-10.0s	kVA dependent		71															
n058	V/f reduction level during speed search (SpdSrch V/f)	Unit: 1% Setting range: 0-100%	kVA dependent		-															
n059	Power loss ridethrough time (PwrL Ridethru t)	Unit: 0.1s Setting range: 0.0-2.0s	kVA dependent		-															
n060	Automatic retry attempts (Num of Restarts)	Unit: 1 time Setting range: 0-10	0		51															
n061	Fault contact selection during automatic retry (Restart Sel)	<table border="1"> <thead> <tr> <th>LED Setting</th> <th>LCD Setting</th> <th>Description</th> </tr> </thead> <tbody> <tr> <td>0</td> <td>Activate Flt Rly</td> <td>Closed during fault retry</td> </tr> <tr> <td>1</td> <td>No Rly Output</td> <td>Open during fault retry</td> </tr> </tbody> </table>	LED Setting	LCD Setting	Description	0	Activate Flt Rly	Closed during fault retry	1	No Rly Output	Open during fault retry	Activate Flt Rly		-						
LED Setting	LCD Setting	Description																		
0	Activate Flt Rly	Closed during fault retry																		
1	No Rly Output	Open during fault retry																		
n062	Jump frequency 1 (Jump Freq 1)	Unit: 0.1Hz Setting range: 0.0-400.0Hz	0.0Hz		60															

No.	Function Name (LCD Operator Display)	Description	Factory Default	User Setting	Ref. Page									
n063	Jump frequency 2 (Jump Freq 2)	Unit: 0.1Hz Setting range: 0.0-400.0Hz	0.0Hz		60									
n064	Jump frequency bandwidth (Jump Bandwidth)	Unit: 0.1Hz Setting range: 0.0-25.5Hz	1.0Hz		60									
n065	Elapsed timer selection (Elapsed Timer)	<table border="0"> <tr> <td>LED Setting</td> <td>LCD Setting</td> <td>Description</td> </tr> <tr> <td>0</td> <td>Time Power is ON</td> <td>Accumulate time during power on</td> </tr> <tr> <td>1</td> <td>Time Running Mtr</td> <td>Accumulate time during running</td> </tr> </table>	LED Setting	LCD Setting	Description	0	Time Power is ON	Accumulate time during power on	1	Time Running Mtr	Accumulate time during running	Time Running Mtr		-
LED Setting	LCD Setting	Description												
0	Time Power is ON	Accumulate time during power on												
1	Time Running Mtr	Accumulate time during running												
n066	Elapsed timer 1 (Elapsed Time 1)	Unit: 1 hour Range: 0-9999 * Initial value becomes 0 only when initialized during CPF4 occurrence.	*		-									
n067	Elapsed timer 2 (Elapsed Time 2)	Unit: 10,000 hours Range: 0-27 * Initial value becomes 0 only when initialized during CPF4 occurrence.	*		-									
n068	DC injection current (DCInj Current)	Unit: 1% Setting range: 0-100% 100% = inverter rated current	50%		54,75									
n069	DC injection time at stop (DCInj Time @ Stop)	Unit: 0.1s Setting range: 0.0-10.0s	0.0s		54									
n070	DC injection time at start (DCInj Time @ Start)	Unit: 0.1s Setting range: 0.0-10.0s	0.0s		55,75									
n071	Torque compensation gain (Torq Comp Gain)	Unit: 0.1 Setting range: 0.0-3.0 (normally, no adjustment is necessary)	1.0		72									
n072	Stall prevention during deceleration (StallP Decel Sel)	<table border="0"> <tr> <td>LED Setting</td> <td>LCD Setting</td> </tr> <tr> <td>0</td> <td>Disabled</td> </tr> <tr> <td>1</td> <td>Enabled</td> </tr> </table>	LED Setting	LCD Setting	0	Disabled	1	Enabled	Enabled		54			
LED Setting	LCD Setting													
0	Disabled													
1	Enabled													
n073	Current limit/Stall prevention level during acceleration (StallP Accel Lvl)	Unit: 1% Setting range: 30-200% When level is set to 200%, current limit during acceleration is disabled.	kVA dependent		52									
n074	Current limit/Stall prevention level during running (StallP Run Level)	Unit: 1% Setting range: 30-200% When level is set to 200%, current limit during running is disabled.	kVA dependent		53									
n075	Frequency agree set point (Freq Det Level)	Unit: 0.1Hz Setting range: 0.0-400.0Hz	0.0Hz		57,84									
n076	Frequency agree detection width (Freq Det Width)	Unit: 0.1Hz Setting range: 0.0-25.5Hz	2.0Hz		84									

No.	Function Name (LCD Operator Display)	Description	Factory Default	User Setting	Ref. Page
n077	Over/Undertorque detection OL3 (Torq Det Sel)	LED <u>Setting</u> <u>LCD Setting</u> <u>Description</u> 0 Disabled Detection disabled 1 OT/Spd Agree/Alm Overtorque detection at speed agree; continue running after detection. (Alarm) 2 OT/Run/Alm Overtorque detection at run; continue running after detection. (Alarm) 3 OT/Spd Agree/Filt Overtorque detection at speed agree; coast to stop after detection. (Fault) 4 OT/Run/Filt Overtorque detection at run; coasts to stop after detection. (Fault) 5 UT/Spd Agree/Alm Undertorque detection at speed agree; continue running after detec- tion. (Alarm) 6 UT/Run/Alm Undertorque detection at run; con- tinue running after detection. (Alarm) 7 UT/Spd Agree/Filt Undertorque detection at speed agree; coast to stop after detection. (Fault) 8 UT/Run/Filt Undertorque detection at run; coast to stop after detection. (Fault)	Disabled		73
n078	Over/Undertorque detection level OL3 (Torq Det Level)	Unit: 1% Setting range: 30~200% 100% = inverter rated current	160%		74
n079	Over/Undertorque detec- tion delay time OL3 (Torq Det Time)	Unit: 0.1s Setting range: 0.1~10.0s	0.1s		74
n080	On-delay timer (On-Delay Timer)	Unit: 0.1s Setting range: 0.0~25.5s	0.0s		80
n081	Off-delay timer (Off-Delay Timer)	Unit: 0.1s Setting range: 0.0~25.5s	0.0s		80
n082	DB resistor overheat function rH (DB Resistor Prot)	LED <u>Setting</u> <u>LCD Setting</u> <u>Description</u> 0 Disabled No DB protection calculated or provided 1 Enabled Protection provided for Yaskawa 3% ED resistor	Disabled		-
n083	Input phase loss detection level SPI (In Ph Loss Lvl)	Unit: 1% Setting range: 1~100% When setting is 100%, this function is disabled.	7%		65
n084	PID selection (PID Mode)	LED <u>Setting</u> <u>LCD Setting</u> <u>Description</u> 0 Disabled PID disabled 1 Enabled D=Fdbk PID enabled 2 Enabled D=Fdwd PID w / Feed forward 3 Enabled RevFdbk PID w / Inverted feedback	Disabled		66,96
n085	Feedback calibration gain PID (PID Fdbk Gain)	Unit: 0.01 Setting range: 0.00~10.00	1.00		66
n086	Proportional gain PID (PID P Gain)	Unit: 0.01 Setting range: 0.0~10.0	1.0		66
n087	Integral time PID (PID I Time)	Unit: 0.1s Setting range: 0.0~100.0s	10.0s		66
n088	Derivative time PID (PID D Time)	Unit: 0.01s Setting range: 0.00~1.00s	0.00s		66
n089	Limit of integral value PID (PID I Limit)	Unit: 1% Setting range: 0~109%	100%		67

No.	Function Name (LCD Operator Display)	Description	Factory Default	User Setting	Ref. Page															
n090	Feedback loss detection PID (PID FdbkLoss Sel)	<table border="0"> <tr> <td><u>LED Setting</u></td> <td><u>LCD Setting</u></td> <td><u>Description</u></td> </tr> <tr> <td>0</td> <td>Disabled</td> <td>Detection is disabled.</td> </tr> <tr> <td>1</td> <td>Multi-function Output Only</td> <td>Detection is enabled.</td> </tr> </table>	<u>LED Setting</u>	<u>LCD Setting</u>	<u>Description</u>	0	Disabled	Detection is disabled.	1	Multi-function Output Only	Detection is enabled.	Disabled		-						
<u>LED Setting</u>	<u>LCD Setting</u>	<u>Description</u>																		
0	Disabled	Detection is disabled.																		
1	Multi-function Output Only	Detection is enabled.																		
n091	Feedback loss detection level PID (PID FdbkLoss Lvl)	Unit: 1% Setting range: 0-100%	0%		-															
n092	Feedback loss detection delay time PID (PID FdbkLoss Tim)	Unit: 0.1s Setting range: 0.0-25.5s	1.0s		66															
n093	PID output selection (PID Output Sel)	<table border="0"> <tr> <td><u>LED Setting</u></td> <td><u>LCD Setting</u></td> </tr> <tr> <td>0</td> <td>Not Inverted</td> </tr> <tr> <td>1</td> <td>Inverted</td> </tr> </table>	<u>LED Setting</u>	<u>LCD Setting</u>	0	Not Inverted	1	Inverted	Not Inverted		67									
<u>LED Setting</u>	<u>LCD Setting</u>																			
0	Not Inverted																			
1	Inverted																			
n094	Sleep function start level PID (Sleep Start Lvl)	Unit: 0.1Hz Setting range: 0.0-400.0Hz	0.0Hz		67															
n095	Sleep function delay time PID (Sleep Delay Time)	Unit: 0.1s Setting range: 0.0-25.5s	0.0s		67															
n096	Energy saving selection (Energy Save Sel)	<table border="0"> <tr> <td><u>LED Setting</u></td> <td><u>LCD Setting</u></td> <td><u>Description</u></td> </tr> <tr> <td>0</td> <td>Disabled</td> <td>Energy saving is disabled.</td> </tr> <tr> <td>1</td> <td>Enabled</td> <td>Energy saving is enabled.</td> </tr> </table>	<u>LED Setting</u>	<u>LCD Setting</u>	<u>Description</u>	0	Disabled	Energy saving is disabled.	1	Enabled	Energy saving is enabled.	Disabled		55,96						
<u>LED Setting</u>	<u>LCD Setting</u>	<u>Description</u>																		
0	Disabled	Energy saving is disabled.																		
1	Enabled	Energy saving is enabled.																		
n097	Energy saving gain K2 (Energy Save Gain)	Unit: 0.01 Setting range: 0.00-655.0 (0=No energy saving)	kVA dependent		55															
n098	Energy saving voltage lower limit at 60Hz (EngSavVLLmt@60Hz)	Unit: 1% Setting range: 0-120%	75%		55															
n099	Energy saving voltage lower limit at 6Hz (EngSavVLLmt@6Hz)	Unit: 1% Setting range: 0-25%	12%		55															
n100	Time of average kW - Energy saving (EngSavTime/AvgkW)	Unit: 1 = 25ms Setting range: 0-200	1		-															
n101	Modbus time over detection (MODBUS Timeout)	<table border="0"> <tr> <td><u>LED Setting</u></td> <td><u>LCD Setting</u></td> <td><u>Description</u></td> </tr> <tr> <td>0</td> <td>Disabled</td> <td>Time Over Detection is disabled.</td> </tr> <tr> <td>1</td> <td>Enabled</td> <td>Time Over Detection is enabled.</td> </tr> </table>	<u>LED Setting</u>	<u>LCD Setting</u>	<u>Description</u>	0	Disabled	Time Over Detection is disabled.	1	Enabled	Time Over Detection is enabled.	Enabled		-						
<u>LED Setting</u>	<u>LCD Setting</u>	<u>Description</u>																		
0	Disabled	Time Over Detection is disabled.																		
1	Enabled	Time Over Detection is enabled.																		
n102	MODBUS stop method at communication error CE (MODBUS Fault Stop)	<table border="0"> <tr> <td><u>LED Setting</u></td> <td><u>LCD Setting</u></td> <td><u>Stop method</u></td> </tr> <tr> <td>0</td> <td>Ramp STOP/Decel 1</td> <td>Ramp to stop - Decel 1 (fault)</td> </tr> <tr> <td>1</td> <td>Coast to STOP</td> <td>Coast to stop (fault)</td> </tr> <tr> <td>2</td> <td>Ramp STOP/Decel 1</td> <td>Ramp to stop - Decel 2 (fault)</td> </tr> <tr> <td>3</td> <td>Continue Oper</td> <td>Continue operation (alarm)</td> </tr> </table>	<u>LED Setting</u>	<u>LCD Setting</u>	<u>Stop method</u>	0	Ramp STOP/Decel 1	Ramp to stop - Decel 1 (fault)	1	Coast to STOP	Coast to stop (fault)	2	Ramp STOP/Decel 1	Ramp to stop - Decel 2 (fault)	3	Continue Oper	Continue operation (alarm)	Coast to STOP		-
<u>LED Setting</u>	<u>LCD Setting</u>	<u>Stop method</u>																		
0	Ramp STOP/Decel 1	Ramp to stop - Decel 1 (fault)																		
1	Coast to STOP	Coast to stop (fault)																		
2	Ramp STOP/Decel 1	Ramp to stop - Decel 2 (fault)																		
3	Continue Oper	Continue operation (alarm)																		
n103	MODBUS frequency reference unit (MODBUS Fref Unit)	<table border="0"> <tr> <td><u>LED Setting</u></td> <td><u>LCD Setting</u></td> <td><u>Stop method</u></td> </tr> <tr> <td>0</td> <td>1=0.1Hz</td> <td>0.1Hz / 1</td> </tr> <tr> <td>1</td> <td>2=0.01Hz</td> <td>0.01Hz / 1</td> </tr> <tr> <td>2</td> <td>3000=100%</td> <td>100% / 30000</td> </tr> <tr> <td>3</td> <td>1=0.1%</td> <td>0.1% / 1</td> </tr> </table>	<u>LED Setting</u>	<u>LCD Setting</u>	<u>Stop method</u>	0	1=0.1Hz	0.1Hz / 1	1	2=0.01Hz	0.01Hz / 1	2	3000=100%	100% / 30000	3	1=0.1%	0.1% / 1	1=0.1Hz		62
<u>LED Setting</u>	<u>LCD Setting</u>	<u>Stop method</u>																		
0	1=0.1Hz	0.1Hz / 1																		
1	2=0.01Hz	0.01Hz / 1																		
2	3000=100%	100% / 30000																		
3	1=0.1%	0.1% / 1																		
n104	MODBUS slave address (MODBUS Address)	Unit: 1 Setting range: 0-31	1		62															

No.	Function Name (LCD Operator Display)	Description	Factory Default	User Setting	Ref. Page
n105	MODBUS BPS selection (MODBUS Baud Rate)	LED Setting 0 2400 Baud 1 4800 Baud 2 9600 Baud	9600 Baud		61
n106	MODBUS parity selection (MODBUS Parity)	LED Setting 0 No parity 1 Even parity 2 Odd parity	No parity		61
n107	Slip compensation gain (Slip Comp Gain)	Unit: 0.1% [of Base Frequency (n013)] Setting range: 0.0 ~ 9.9%	0.0%		77
n108	Motor no-load current (Mtr No-Load Amp)	Unit: 1% [of Motor Rated Current (n033)] Setting range: 0 ~ 99%	30%		-
n109	Slip compensation primary delay time constant (Slip Comp Delay)	Unit: 0.1s Setting range: 0.0 ~ 25.5s	2.0s		77
n110	Operator connection fault detection selection (Oper Detect Flt)	LED Setting 0: Disabled 1: Enabled	Disabled		-
n111	Local / Remote changeover function selection (LOC/REM Change)	LED Setting 0 Cycle Extern RUN command 1 Accept Extern RUN command	Cycle Extern RUN		37
n112	Low frequency OL start point (Low Freq OL2 Start)	Unit: 0.1Hz Setting range: 0.0 ~ 10.0Hz	6.0Hz		-
n113	0Hz continuous operation level (OL2_Level_@_0 Hz)	Unit: 1% Setting range: 25 ~ 100%	50%		-
n114	Not used	-	-	-	-
n115	kVA selection (Inverter kVA Sel)	Unit: 1 Setting range: PC5 (0-8, 20-29), P5(9-F, 2A-35)	kVA Dependent		-
n116	CT / VT selection (CT / VT Selection)	LED Setting 0: CT Operation 1: VT Operation			7,9
		<u>LCD Setting</u> Description Constant torque Variable torque			

3.2 PARAMETER SET-UP & INITIALIZATION

Parameter Selection/Initialization (*n001, Password*)

The following table describes data which can be set or read when parameter n001 is set.

Setting	Parameters that can be set	Parameters that can be viewed
0 (parameter read-only)	<i>n001</i>	<i>n001 to n116</i>
1 (factory default)	<i>n001 to n035</i>	<i>n001 to n116</i>
2	<i>n001 to n053</i>	<i>n001 to n116</i>
3	<i>n001 to n116</i>	<i>n001 to n116</i>

Setting	Parameters that can be set	Parameters that can be viewed
4, 5	Not used	
6	Initialize: 2-wire sequence (Japanese specifications)	
7	Initialize: 3-wire sequence (Japanese specifications)	
8	Initialize: 2-wire sequence (American specifications)	
9	Initialize: 3-wire sequence (American specifications)	

3.3 VS-616PC5/P5 OPERATION

Accel/Decel Time Adjustment

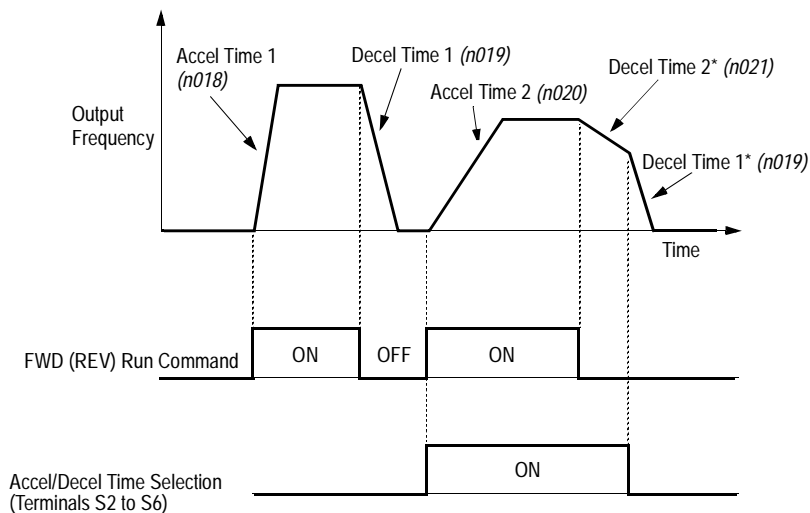

* When "deceleration to stop" is selected (n004 = "Ramp to STOP")

Figure 18 Timing Diagram of Accel/Decel Time Adjustment

When any of the multi-function input terminal selections (n036, n037, n038,

n039 or *n040*) is set to “Acc/Dec Switch”, accel/decel times can be selected by opening or closing the appropriate terminal (S2, S3, S4, S5 or S6).

At OPEN: *n018* (accel time 1), *n019* (decel time 1)

At CLOSED: *n020* (accel time 2), *n021* (decel time 2)

Parameter No.	Name	Unit	Setting Range	Factory Default
<i>n018</i>	Acceleration time 1	0.1s *	0.0 to 3600s	10.0s
<i>n019</i>	Deceleration time 1	0.1s *	0.0 to 3600s	10.0s
<i>n020</i>	Acceleration time 2	0.1s *	0.0 to 3600s	10.0s
<i>n021</i>	Deceleration time 2	0.1s *	0.0 to 3600s	10.0s

* Setting unit is 1s for 1,000s and above.

- Acceleration time

Sets the time necessary for the output frequency to move from 0Hz to maximum output frequency (*n011*).

- Deceleration time

Set the time necessary for the output frequency to move from maximum output frequency (*n011*) to 0Hz.

Automatic Fault Retry (*n060*, Num of Restarts)

After a fault occurs, the inverter can automatically restart. The number of retry attempts can be set up to 10 times via parameter *n060*. The inverter can be set to automatically restart after the following faults occur:

- Overcurrent (OC)
- Overvoltage (OV)
- Undervoltage PUV (UV1)
- Ground fault (GF)
- Regenerative transistor fault (RR)

The number of retry attempts are cleared to “0” in the following cases:

- If no other fault occurs within 10 minutes after retry.
- When the fault reset signal is ON (closed) after the fault is detected.
- Power supply is turned OFF.

Automatic Restart After Momentary Power Loss (*n055*, PwrL Selection)

When momentary power loss occurs, operation restarts automatically. The run command must remain closed for this feature to function properly.

LED Setting	LCD Setting	Description
0	Not Provided	Not provided (<i>factory default</i>)
1 *	2 Seconds Max	Continuous operation after power recovery within 2 seconds





LED Setting	LCD Setting	Description
2 **	CPU Power Active	Continuous operation after power recovery within control logic time (no fault output)

* Holds the operation signal to continue operation after recovery from momentary power loss.

** When "CPU Power Active" is selected, operation restarts if power supply voltage returns to its normal level (level before power loss). No fault signal is output.

Carrier Frequency (n054, Carrier Freq Sel)

This function sets the inverter output transistor switching frequency (carrier frequency). This is used to reduce motor noise and leakage current. The factory setting for carrier frequency is the maximum allowable carrier frequency at which inverter rated current can continuously be generated. Consult the factory when increasing the carrier above the default values.

Carrier Frequency (kHz)		Metallic Noise from Motor	Leakage Current
<u>LED Setting</u>	<u>LCD Setting</u>		
1	2.5	Louder	Smaller
2	5.0		
3	8.0		
4	10.0		
5	12.5		
6	15.0		

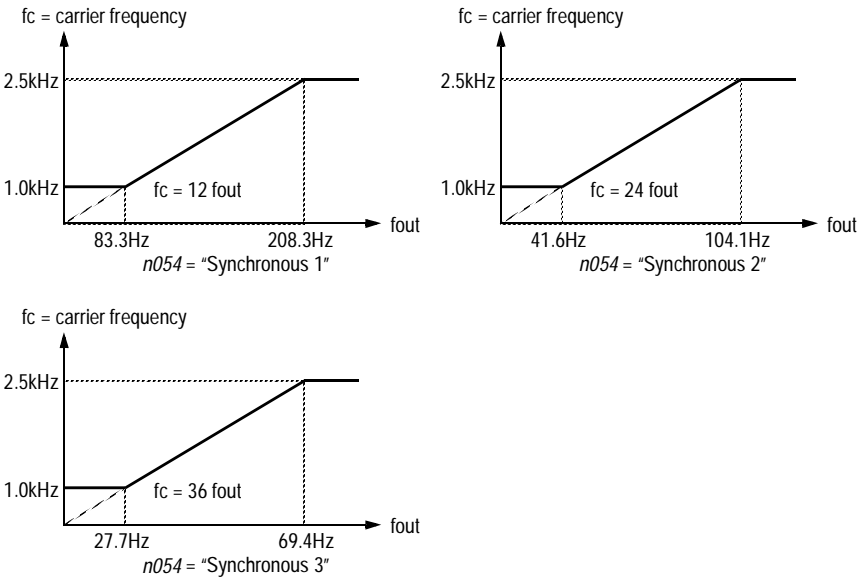

Figure 19 Custom Setting of Carrier Frequency Patterns

Current Limit (Stall Prevention)

This function automatically adjusts the output frequency in response to an increase in load current to continue operation without tripping the inverter.

- **Stall Prevention Level During Acceleration (n073, StallP Accel Lvl)**

The current limit level during acceleration can be set in units of 1% (inverter rated current = 100%).

Factory setting: kVA dependent

A setting of 200% disables current limit during acceleration. During acceleration, if the output current exceeds the value set for n073, acceleration stops and frequency is maintained. When the output current goes down below the value set for parameter n073, acceleration resumes at the normal acceleration rate.

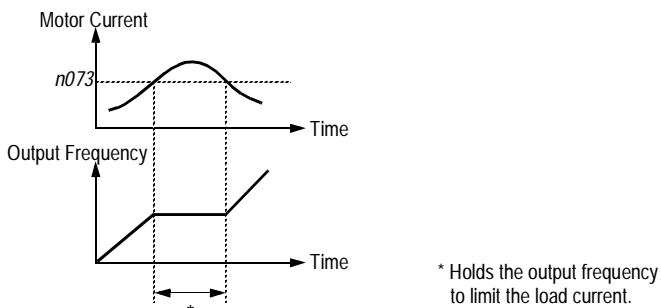

Figure 20 Stall Prevention During Acceleration

In the constant output area [output frequency \geq base frequency (*n013*)], the current limit level during acceleration is changed by the following equation:

$$\boxed{\text{Current Limit Level During Accel in Constant Output Area}} = \boxed{\text{Current Limit Level During Acceleration (n073)}} \times \frac{\text{Base Frequency (n013)}}{\text{Output Frequency}}$$

· **Stall Prevention Level During Running (*n074, StallP Run Level*)**

The stall prevention level during running can be set in units of 1% (inverter rated current = 100%).

Factory setting: kVA dependent

A setting of 200% disables current limit during running. During speed agree, if the output current exceeds the value set for parameter *n074*, then deceleration is initiated.

While the output current exceeds the value set for *n074*, deceleration continues. When the output current goes below the value set for parameter *n074*, acceleration begins at the normal acceleration rate bringing

the motor to the set frequency.

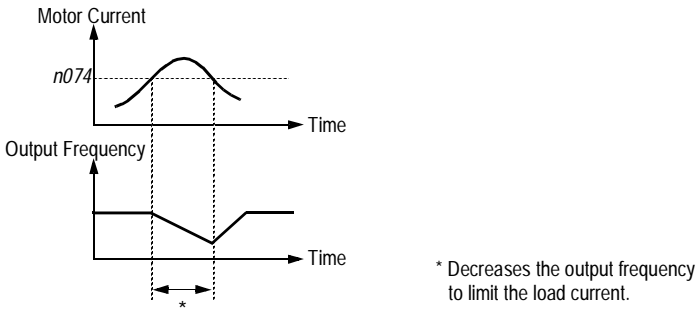

Figure 21 Stall Prevention During Running

- Stall prevention during deceleration (*n072, StallP Decel Sel*)
To prevent overvoltage during deceleration, the inverter automatically extends the deceleration time according to the value of main circuit DC voltage. When using an optional braking resistor for the VS-616PC5, set parameter *n072* to "0".

LED Setting	LCD Setting	Stall Prevention During Deceleration
0	Disabled	Disabled (when optional braking resistor mounted)
1	Enabled	Enabled (factory default)

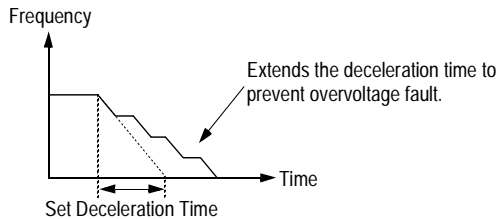

Figure 22 Stall Prevention During Deceleration

DC Injection Braking

- DC Injection Braking Current (*n068, DCInj Current*)
DC injection braking current can be set in increments of 1%. (100% = inverter rated current)
- DC injection Braking Time at Stop (*n069, DCInj Time @ Stop*)
DC injection braking time at stop can be set in increments of 0.1 second. When parameter *n069* is set to "0", DC injection braking at stop-

ping is disabled.

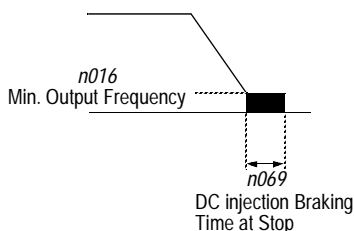

Figure 23a DC Injection Braking Time at Stop

When coast to stop is selected in the stopping method selection (*n004*), DC injection braking at stop is disabled.

- DC injection Braking Time at Start (*n070*)
DC injection braking time at start can be set in increments of 0.1 second. When parameter *n070* is set to “0”, DC injection braking at starting is disabled.

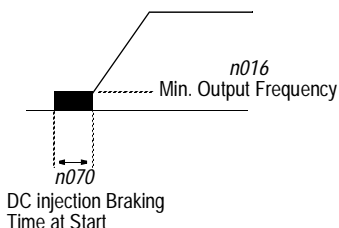

Figure 23b DC Injection Braking Time at Start

Energy Saving Control

To enable energy saving control, set energy saving selection (*n096, Energy Sav Sel*) to “1”.

LED Setting	LCD Setting	Description
0	Disabled	Energy saving is disabled (<i>factory default</i>).
1	Enabled	Energy saving is enabled.

Since the parameters used in the energy saving control mode have been preset at the factory to the optimum values, it is not necessary to adjust them under normal operation. If your motor characteristics differ greatly from those of standard induction motors, refer to the following descrip-

tion to adjust the parameters.

Energy Saving Control Mode

- Energy Saving Gain K2 (*n097, Energy Save Gain*)

Use this energy saving gain when running in the energy saving control mode to calculate the voltage at which motor efficiency will be greatest, and set it as the output voltage reference. This value is preset at the factory to the standard induction motor value prior to shipment. As the energy saving gain increases, output voltage decreases.

- Energy Saving Voltage Lower Limit (*n098, EngSavVLLmt@60Hz;*
n099, EngSavVLLmt@ 6Hz)

Sets the output voltage lower limit. If the voltage reference value calculated in the energy saving mode is smaller than the specified lower limit, this lower limit value is output as the voltage reference value. The lower limit value is set in order to prevent stalling at light loads. Set voltage limits at 6Hz and 60Hz; a value obtained by linear interpolation should be used to set any limit values other than at 6Hz or 60Hz. Setting is made as a percentage of motor rated voltage.

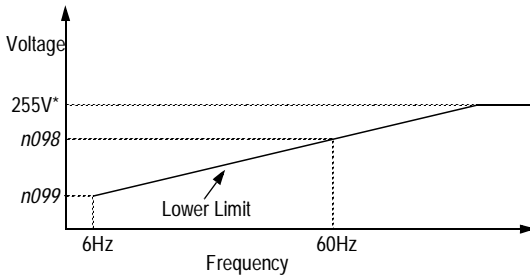

* This value is doubled for 460V class inverters.

Figure 24 Energy Saving Voltage Lower Limit

Frequency Agree Set Point (n075, Freq Det Level)

When multi-function contact output selections *n041* or *n042* are set to “Freq Det 1” or “Freq Det 2”, frequency detection is enabled. This function is activated when the output frequency is above or below the frequency agree set point (*n075*).

- Output frequency \leq Frequency agree set point
Set *n041* or *n042* to “Freq Det 1”.

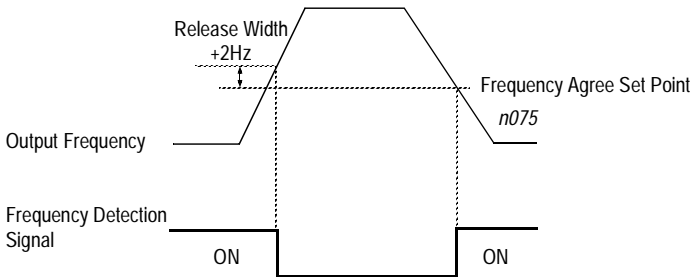

Figure 26 Frequency Agree Set Point Example
(Fout ≤ Frequency Agree Set Point)

- Output frequency \geq Frequency agree set point

Set *n041* or *n042* to “Freq Det 2”.

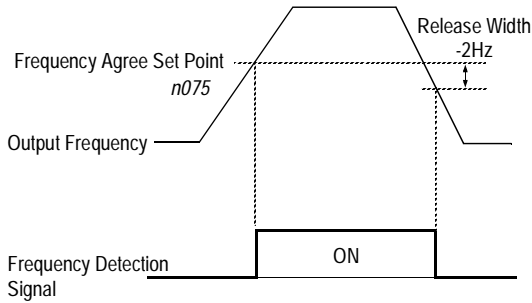

Figure 27 Frequency Agree Set Point Example
($F_{out} \geq$ Frequency agree set point)

Frequency Meter or Ammeter (*n052*, Terminal AM Sel)

This parameter selects whether the signal (on terminals AM and AC) is proportional to output frequency, output current, output power, or DC bus voltage for external monitoring.

Setting	Analog Monitor Output Selection
Output Freq	Output frequency (10V/max. frequency) - factory default
Output Amps	Output current (10V/inverter rated current)
Output kWatts	Output power (10V/inverter rated power)
DC Bus Voltage	DC bus voltage [10V/400VDC (230V class), 10V/800VDC (460V class)]

Frequency Meter or Ammeter Calibration (*n053*, Terminal AM Gain)

This function is used to adjust the analog monitor output signal level.

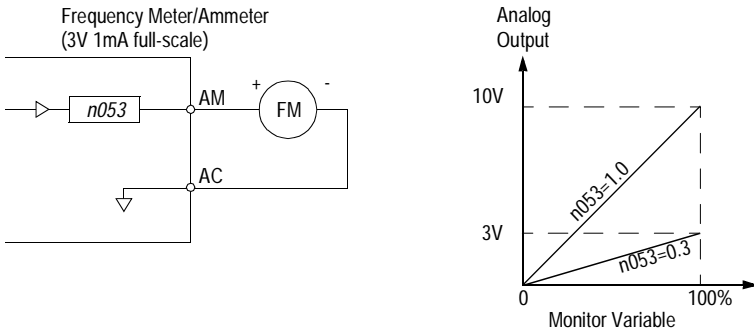

Figure 28 Frequency Meter/Ammeter Calibration

Parameter *n053* determines the slope of the signal output on terminal AM

for the variable being monitored. Increasing this value increases the slope. Refer to Figure 28.

Frequency Signal Adjustment

When the frequency reference is given by an analog signal at control circuit terminals FV and FI, the relation between analog voltage (or current) and frequency reference can be set.

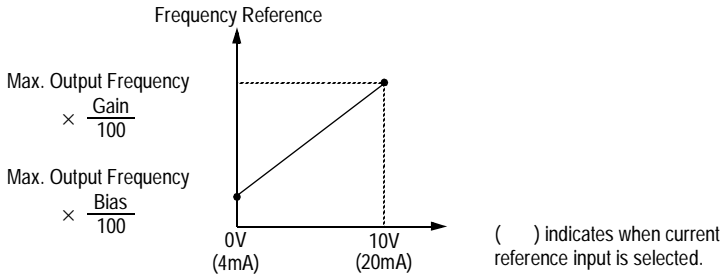

Figure 29 Frequency Signal Adjustment

- Terminal FV Gain (*n048, Terminal FV Gain*)
The analog input voltage value for the maximum output frequency (*n011*) can be set in units of 1%, from 0 to 200%.
Factory setting: 100%
- Terminal FV Bias (*n049, Terminal FV Bias*)
The frequency reference that is generated when the analog input is 0V can be set in units of 1%, from -100% to 100%. (*n011*: maximum output frequency = 100%)
Factory setting: 0%
- Terminal FI Gain (*n050, Terminal FI Gain*)
The analog input current value for the maximum output frequency (*n011*) can be set in units of 1%, from 0 to 200%.
Factory setting: 100%
- Terminal FI Bias (*n051, Terminal FI Bias*)
The frequency reference that is generated when the analog input is 4mA can be set in units of 1%, from -100% to 100%. (*n011*: maximum output frequency = 100%)
Factory setting: 0%
- Examples

To operate the inverter with a frequency reference of 0% to 100% at a 0 to 5V input:

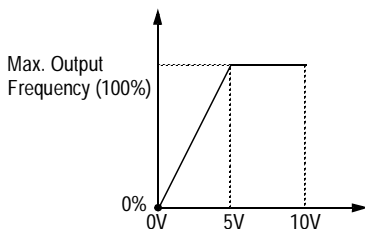

Figure 30 Frequency Signal Adjustment Example - 0 to 5V input

Gain: Parameter *n048* = “200”

Bias: Parameter *n049* = “0”

To operate the inverter with a frequency reference of 50% to 100% at a 0 to 10V input:

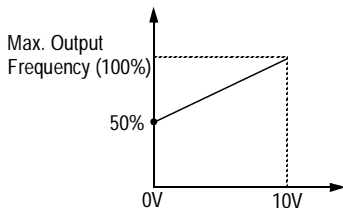

Figure 31 Frequency Signal Adjustment Example - 0 to 10V input

Gain: Parameter *n048* = “100”

Bias: Parameter *n049* = “50”

Jog Operation

Multi-function inputs (Terminals S2 to S6) can be programmed to function as a jog reference selection. Operation can then be enabled at the jog frequency reference set in parameter *n030* by activating this input. A “RUN” command must also be given to start the inverter. When multi-step speed references 1 or 2 are input simultaneously with the jog frequency reference, the jog frequency reference has priority.

Name	Parameter No.	Setting
Jog frequency reference	<i>n030</i>	6.0Hz (Factory default)

Name	Parameter No.	Setting
Multi-function contact input selection (S2 to S6)	<i>n036, n037, n038, n039, n040</i>	Set to "Jog Command" for any parameter.

Jump Frequencies (n062, Jump Freq 1; n063, Jump Freq 2, n064, Jump Bandwidth)

This function enables the “jumping” of critical frequencies so that systems can operate without excessive vibration or noise. Setting the value to 0.0Hz disables this function.

Set jump frequency 1 or 2 such that $n062 \leq n063$. If this condition is not satisfied, the inverter displays the parameter setting error “OPE6”.

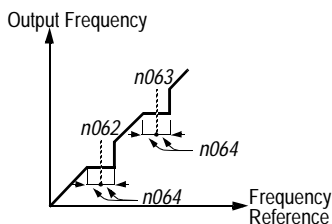

Figure 32 Jump Frequencies

MODBUS Communication

The VS-616PC5/P5 can perform serial transmission by using a programmable controller (PLC) and MODBUS communication. MODBUS is composed of one master PLC and 1 to 31 (maximum) slave inverters. In signal transmission between master and slave units, the master unit always starts transmission and the slave units respond to it.

The master unit performs signal transmission with one slave unit at a time. Hence, different address numbers must be assigned to each slave unit in advance and the master unit specifies a number to perform signal transmission. The slave unit which receives the command from the master unit executes the function and returns the response to the master unit.

Communication Specifications

- Interface: RS-485, RS-422 (communication interface card SI-K2/P must be mounted.)
- Synchronization: Asynchronous
- Transmission parameter: Baud rate: selectable from 2400, 4800, 9600 BPS (parameter *n105*)
Data length: fixed at 8 bits
Parity: parity/no parity, even/odd select-

-
- | | |
|--|--------------------------------|
| | able (parameter <i>n106</i>) |
| | Stop bit: fixed at 1 bit |
| · Protocol: | In accordance with MODBUS |
| · Maximum number of units to be connected: | 31 units (when RS-485 is used) |

Data to be Sent/Received by Communication

Data to be sent/received by communication are run commands, frequency reference, fault contents, inverter status and parameter setting/reading.

- Operation Mode Selection (*n002, Oper Mode Select*)
Select the run command and frequency reference input method in parameter *n002*. To provide a run command and/or frequency reference by communication, set this parameter to a selection that contains “COM” for SEQ and/or REF. Regardless of this selection, monitoring of running status, parameter setting/reading, fault reset and multi-function input commands from the PLC are possible. The multi-function input command becomes “OR” with the command input from control circuit terminals S2 to S6.
- MODBUS Frequency Reference Unit (*n103, MODBUS Fref Unit*)
The frequency reference units from the PLC and in the frequency reference and output frequency monitors (by communication) are set with parameter *n103*. The output frequency resolution of the VS-616PC5/P5 is 0.1Hz. Even if the frequency reference unit is changed to 0.01Hz in parameter *n103*, the value in the hundredth digit of the received frequency reference is rounded off internally. When 30,000/100% in units of 0.1% is selected, the value is rounded off in the same way.
- MODBUS Slave Address (*n104, MODBUS Address*)
Sets the slave address number. It is necessary to set the address number so that it will not overlap with the address number of another slave unit connected on the same transmission line.

Note: To change the values set in parameters *n104* to *n106* and enable new settings, it is necessary to cycle power after entering the desired values.

Motor Overload Detection

The VS-616PC5/P5 protects against motor overload with a UL-recognized, built-in electronic thermal overload relay function.

- Motor Rated Current (*n033, Motor Rated FLA*)
Set to the rated current value shown on the motor nameplate.

Note: setting to 0.0A disables the motor overload protection function.

· Motor overload protection selection (*n034, Motor OL Sel*)

LED Setting	LCD Setting	Electronic Thermal Characteristics
0	Disabled	Protection disabled
1	STD Motor / 8 min	Applied to general-purpose motor, standard rating (Class 20 overload)
2	STD Motor / 5 min	Applied to general-purpose motor, short time rating (Class 10 overload)
3	INV Motor / 8 min	Applied to blower-cooled / inverter duty motor, standard rating (Class 20 overload)
4	INV Motor / 5 min	Applied to blower-cooled / inverter duty motor, short time rating (Class 10 overload)

The electronic thermal overload function estimates motor temperature, based on inverter output current and time, to protect the motor from overheating. When the electronic thermal overload relay is activated, an “oL1” error occurs, shutting OFF the inverter output and preventing excessive overheating in the motor.

When operating with one inverter connected to one motor, an external thermal relay is not needed. When operating several motors with one inverter, install a thermal relay on each motor. In this case, set parameter *n034* to “Disabled”.

· General-purpose and Blower-cooled Motors

Induction motors are classified as general-purpose or blower-cooled motors, based on their cooling capabilities. Hence, the motor overload

detection function operates differently for each of these two motor types.

	Cooling Effectiveness	Torque Characteristics	Electronic Thermal Overload
General-purpose	Effective when operated at 50/60Hz from commercial power supply.	<p>Base Frequency 60Hz (V/f for 60Hz, 230V Input Voltage)</p> <p>During continuous operation at low speeds, the load must be limited in order to limit motor temperature rise.</p>	“OL1” error (motor overload protection is enabled when motor is continuously operated at 50/60Hz or less at 100% load).
Blower-cooled	Effective when operated at low speeds (approx. 6Hz).	<p>Base Frequency 60Hz (V/f for 60Hz, 230V Input Voltage)</p> <p>Use blower-cooled motor for continuous operation at low speeds.</p>	Effective when operated at low speeds (approx. 6Hz).

Multi-Step Speed Selection

This function allows the programming of up to 4 preset speeds, through multi-function contact input selections.

4-step speed selection

$n002 = \text{“SEQ=X REF=OPR”}$, where “X” can be TRM, OPR, or COM

$n024 = 30.0\text{Hz}$ (factory default = 0.0Hz)

$n025 = 40.0\text{Hz}$ (factory default = 0.0Hz)

$n026 = 50.0\text{Hz}$ (factory default = 0.0Hz)

$n027 = 60.0\text{Hz}$ (factory default = 0.0Hz)

$n039 = 9$ (multi-function contact input terminal S5)

$n040 = 10$ (multi-function contact input terminal S6)

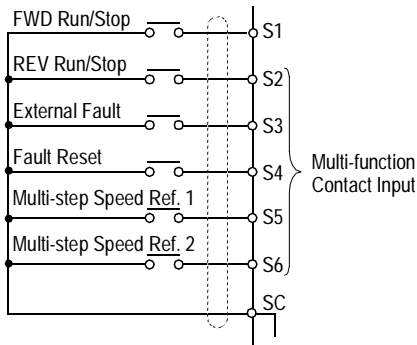

Figure 33 Multi-step Speed Selection - Control Circuit Terminals

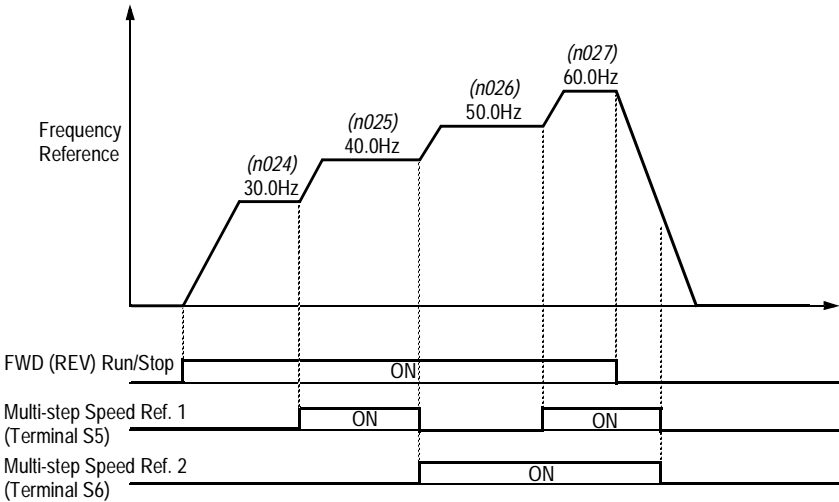

Figure 34 Multi-step Speed Operation - Timing Diagram

Phase Loss Protection

- Input Phase Loss Detection ($n083$, *In Ph Loss Lvl*)

The input phase loss detection circuit monitors the DC bus current ripple

and activates when one of the input phases are lost. The detection circuit calculates the maximum and minimum values of the DC bus voltage in 1.28 second intervals, and compares the difference (ΔV) between these values with the input phase loss detection level ($n083$). If $\Delta V \geq n083$, then input phase loss is detected; and after the input phase loss detection delay time (fixed at approximately 10 seconds), an SPI fault occurs, and the motor coasts to stop.

No.	Name	Description	Factory Default
<i>n083</i>	Input phase loss detection level	Unit: 1% Setting range: 1 to 100% of input voltage	7%

Input phase loss detection is disabled in the following cases:

- Parameter *n083* is set to “100%”
- A Stop command is input
- Input magnetic contactor (MC) shuts OFF
- CPU A/D converter fault (CPF5)
- During deceleration
- Output current $\leq 30\%$ of Inverter rated current

PID Control

To enable PID control, set PID selection (*n084*) to “Enabled”, according

to the description below.

LED Setting	LCD Setting	Description
0	Disabled	PID disabled (<i>factory default</i>)
1	Enabled D=Fdbk	PID enabled (deviation is D-controlled.)
2	Enabled D=Fdfwd	PID with feed forward (feedback value is D-controlled)
3	Enabled Rev Fdbk	PID with inverted feedback

Then select the PID control setpoint value and detected feedback value setpoint as follows:

- **Setpoint Value Selection**

The control circuit terminal FV voltage signal (0 to 10V) or multi-step speed parameters *n024* to *n027* can be used to select the PID setpoint value.

Control circuit terminal FV voltage signal:

Set operation mode selection (*n002*) to “SEQ=OPR REF=TRM” or “SEQ=TRM REF=TRM”.

Multi-step speed constants (*n024* to *n027*):

Set operation mode selection (*n002*) to “SEQ=OPR REF=OPR” or “SEQ=TRM REF=OPR”.

(combination of multi-step speed reference and jog frequency reference)

- **Detected Value Setting**

The control circuit terminal FI current signal (4 to 20mA) or voltage signal (0 to 10V) can be used to set the PID detected value.

Control circuit terminal FI current signal:

Set aux. analog input selection (*n044*) to “4-20mA”.

Control circuit terminal FI voltage signal:

Set operation mode selection (*n044*) to “0-10VDC”.

(Cut jumper J1 on the control PCB board.)

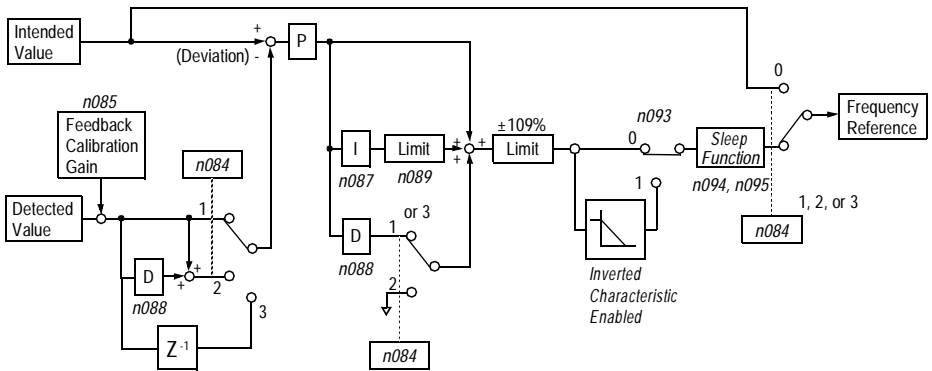
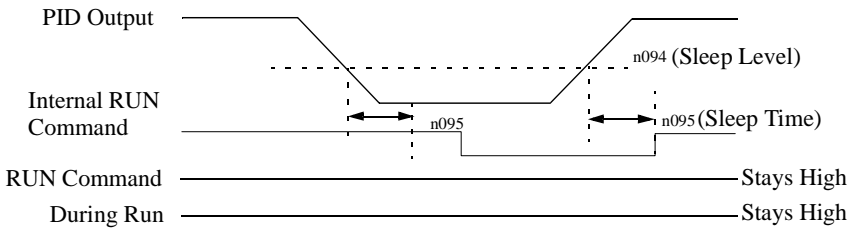

Figure 35a PID Control Block Diagram

Notes:

- 1) Value I is reset to "0" in the following cases:
 - When operation stops
 - When the integral value reset signal is input by multi-function contact input selection (Any of parameters $n036$ to $n040$ are set to "PID I Reset").
- 2) The upper limit of value I can be set by parameter $n089$.
 Increase the value of parameter $n089$ to upgrade control capability by integration. If the control system vibrates and it cannot be stopped by adjusting the integral time, output lag filter time, etc., decrease the set value of parameter $n089$.
- 3) PID control can be canceled by a multi-function contact input signal.
 By setting any of parameters $n036$ to $n040$ to "PID Disable" and by closing the contact during running, PID control is disabled and the setpoint value signal itself is used as a frequency reference signal.
- 4) Inverse PID characteristics can be obtained by setting parameter $n093$ to "Inverted".
- 5) The PID Sleep feature can be used to automatically turn off the inverter output when the PID output value falls below the sleep function level ($n094$) for longer than the sleep function time ($n095$). The inverter will resume normal operation when the PID output is greater than the sleep level for longer than the sleep time. Setting parameter $n094$ to "0.0" disables this feature.



Reverse Run Prohibit (n006, Reverse Oper)

A “reverse run disabled” setting does not accept a reverse run command from the control circuit terminal or the digital operator. This setting is used in applications where a reverse run command can cause problems.

LED Setting	LCD Setting	Description
0	REV Allowed	Reverse run enabled (<i>factory default</i>)
1	REV Prohibited	Reverse run disabled

Soft-Start Characteristics (n022, S-Curve Select)

An S-curve pattern is used to reduce shock and provide smooth transitions during machine acceleration and deceleration.

LED Setting	LCD Setting	Description
0	No S-Curve	S-curve not provided
1	0.2 Sec	0.2 second (<i>factory default</i>)
2	0.5 Sec	0.5 second
3	1.0 Sec	1.0 second

Note: The S-curve time is the time to reach the set accel/decel rate (as determined by the accel/

decel time settings).

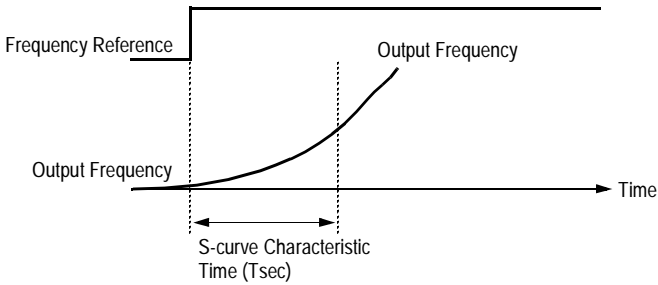

Figure 36 S-curve Characteristic Timing Diagram

The following figure shows FWD/REV run switching during deceleration to stop.

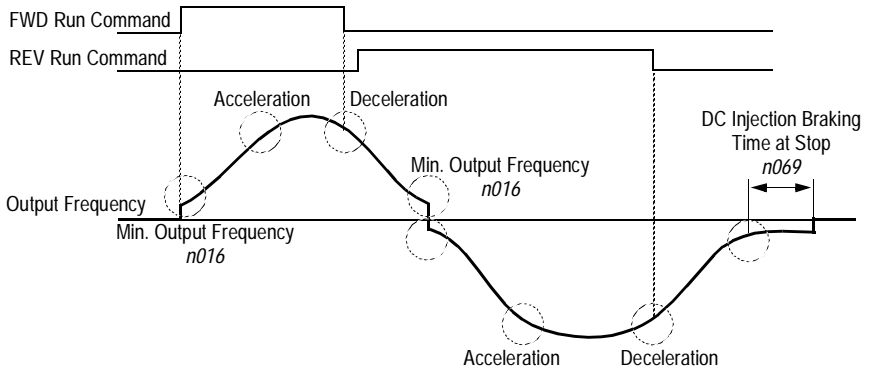

Figure 37 S-curve Characteristics - FWD/REV Operation

Speed Limit Adjustment

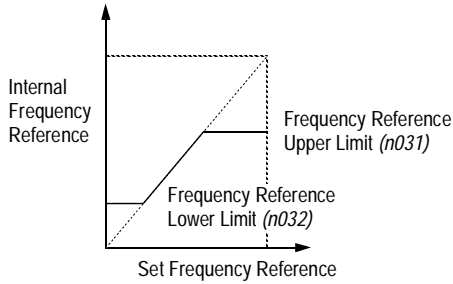

Figure 38 Setting Frequency Upper and Lower Limits

- Frequency Reference Upper Limit (*n031, Ref Upper Limit*)

The upper limit of the frequency reference can be set in increments of 1%. (*n011*: maximum output frequency = 100%)

Factory setting: 100%

- Frequency Reference Lower Limit (*n032, Ref Lower limit*)

The lower limit of the frequency reference can be set in increments of 1%. (*n011*: maximum output frequency = 100%)

Factory setting: 0%

When operating at a frequency reference of 0Hz, operation continues at the frequency reference lower limit. However, when the lower limit is set to less than the minimum output frequency (*n016*), operation stops.

Stopping Method (*n004, Stopping Method*)

This function selects the stopping method suitable for the particular application.

LED Setting	LCD Setting	Description
0	Ramp to STOP	Deceleration to stop (<i>factory default</i>)
1	Coast to STOP	Coast to stop
2	Coast w/Timer 1	Coast to stop with timer 1 (run command cycle)
3	Coast w/Timer 2	Coast to stop with timer 2 (auto-start after time out)

· Deceleration to Stop ($n004 = \text{“Ramp to STOP”}$)

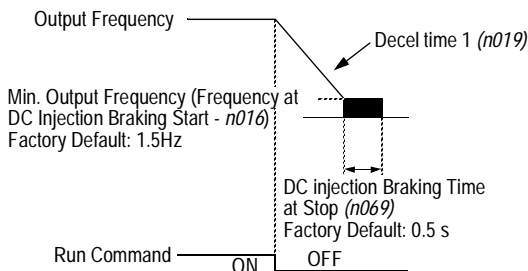

Figure 39 Stopping Method - Deceleration to Stop

Upon removal of the FWD (REV) run command, the motor decelerates at a deceleration rate determined by the time set in deceleration time 1 ($n019$) and DC injection braking is applied immediately before when the minimum output frequency ($n016$) is reached. If the deceleration time is short or the load inertia is large, an overvoltage fault (OV) may occur during deceleration. In this case, increase the deceleration time or install an optional braking resistor (available for the VS-616PC5 *only*).

Braking torque: w/o braking resistor, approx. 20% of motor rated torque
w/ braking resistor, approx. 150% of motor rated torque

· Coast to Stop ($n004 = \text{“Coast to STOP”}$)

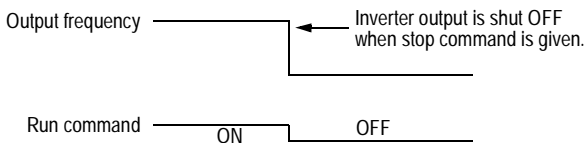

Figure 40 Stopping Method - Coast to Stop

Upon removal of the FWD (REV) run command, the motor coasts.

· Coast to Stop with Timer 1 ($n004 = \text{“Coast w/Timer 1”}$)

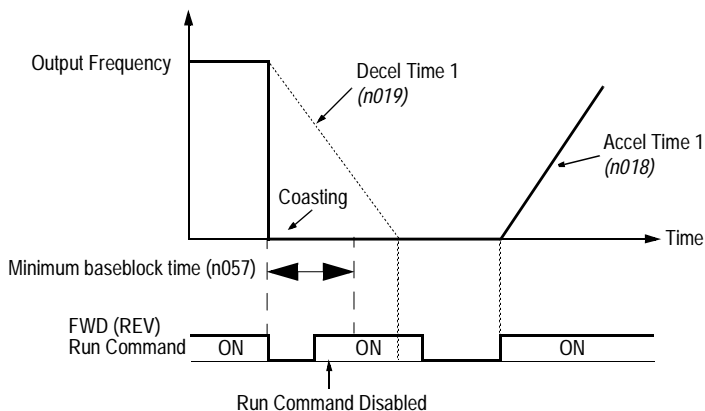

Figure 41 Example of Stopping Method - Coast to Stop w/ Timer 1

Upon removal of the run command, the inverter output is immediately removed, allowing the motor to coast. If the run command is re-applied before the minimum baseblock time ($n057$) elapses, the run command is not accepted. The run command must be cycled to be acknowledged. An initial run command will be accepted if applied after the minimum baseblock time elapses.

· Coast to Stop with Timer 2 ($n004 = \text{“Coast w/Timer 2”}$)

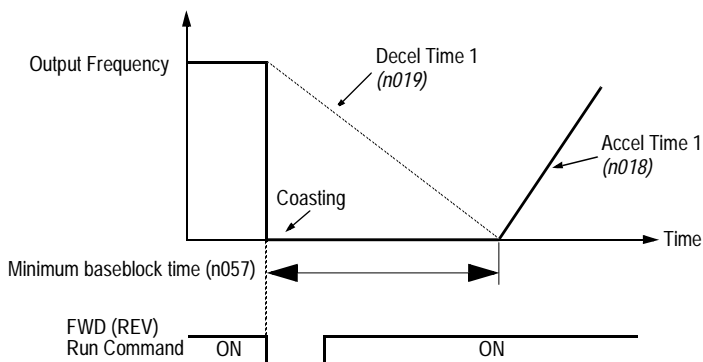

Figure 42 Example of Stopping Method - Coast to Stop w/ Timer 2

Operation is disabled during the minimum baseblock time ($n057$) after a stop command is given. A run command will be accepted, but operation does not start until the minimum baseblock time runs out. The inverter

does not operate during the baseblock time, as shown in Figure 42.

Torque Adjustment (n071, Torq Comp Gain)

Motor torque can be adjusted by changing the V/f pattern (n010) or by adjusting the torque compensation gain (n071). For details on setting the V/f pattern, see “V/f Pattern Adjustment”, on page 75.

- Full-range Automatic Torque Boost

The motor torque requirement changes according to load conditions. Full-range automatic torque boost adjusts the output motor voltage according to the required torque. The VS-616PC5/P5 automatically adjusts the voltage during constant-speed operation as well as during acceleration.

The required torque is calculated by the inverter. The optimum motor voltage will be output to ensure tripless operation and power savings.

Output voltage \propto Torque compensation gain \times Required torque

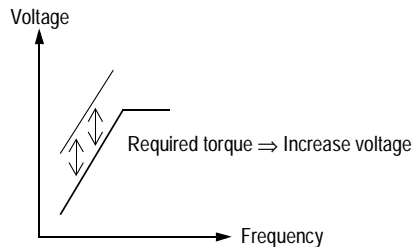

Figure 43 Torque Characteristics

Normally, no adjustment is necessary for torque compensation gain (n071, factory default: “1.0”). When the wiring distance between the inverter and the motor is long, or when the motor generates vibration, change the torque compensation gain.

Increasing torque compensation gain increases motor torque, but an excessive increase may cause the following:

- Inverter trips due to motor overexcitation
- Motor overheat or excessive vibration

If adjustment is necessary, adjust in 0.1 increments.

Torque Detection

The over/undertorque detection circuit will activate when the motor load causes the motor current to go above or below torque detection level ($n078$) respectively. When the over/undertorque condition is detected, alarm signals are sent to multi-function output terminals MA, MB and/or M1. To output an over/undertorque detection signal, set multi-function contact output selection $n041$ or $n042$ to “6” (N.O. contact) or “7” (N.C. contact).

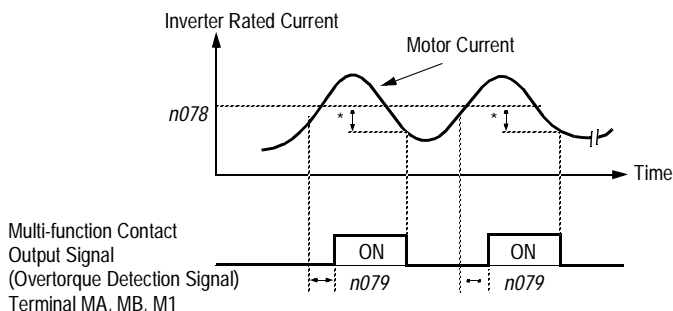

* Release width (hysteresis) during overtorque detection is 5% of the inverter rated current level.

Figure 43 Torque Characteristics

· Over/undertorque Detection Function Selection ($n077$, Torq Det Sel)

LED Setting	LCD Setting	Description
0	Disabled	Detection disabled (<i>factory default</i>)
1	OT/SpdAgree/Alm	Overtorque detection begins at speed agree; continue running after detection. (Alarm)
2	OT/Run/Alm	Overtorque detection at run; continue running after detection. (Alarm)
3	OT/SpdAgree/Flt	Overtorque detection begins at speed agree; coast to stop after detection. (Fault)
4	OT/Run/Flt	Overtorque detection at run; coasts to stop after detection. (Fault)
5	UT/SpdAgree/Alm	Undertorque detection begins at speed agree; continue running after detection. (Alarm)
6	UT/Run/Alm	Undertorque detection at run; continue running after detection. (Alarm)
7	UT/SpdAgree/Flt	Undertorque detection begins at speed agree; coast to stop after detection. (Fault)
8	UT/Run/Flt	Undertorque detection at run; coast to stop after detection. (Fault)

Notes:

- To detect torque during acceleration or deceleration, select a setting that contains “RUN”.
- To continue operation after over/undertorque detection, select a setting that contains “Alm”. During detection, the digital operator displays “oL3” alarm (blinking).
- To stop the inverter after an over/undertorque detection fault, select a setting that

contains “Flt”. During detection, the digital operator displays “oL3” fault.

- **Over/undertorque Detection Level (*n078, Torq Det Level*)**
Sets the torque detection current level in units of 1%
Inverter rated current: 100%
Factory default: 160%
- **Over/undertorque Detection Time (*n079, Torq Det Time*)**
The over/undertorque detection delay time inserts a delay, between the time motor current exceeds or falls below the over/undertorque detection current level (*n078*) and when the over/undertorque detection function is enabled.
Factory default: 0.1 second

If the time during which motor current exceeds or falls below the over/undertorque detection level (*n078*) is longer than the over/undertorque detection time (*n079*), the over/undertorque detection function is enabled.

Tripless Operation

When starting into a coasting motor, use the speed search command or DC injection braking at start, to prevent a drive trip and motor burnout.

- **Speed search**

This function allows the restart of a coasting motor without the necessity to stop. It is useful during inverter bypass operation, when switching between the motor receiving power directly from the line to the inverter.

Set the multi-function contact input selection (*n036* to *n40*) to “SpdSrch (MAXFREQ)” (start search command from maximum output frequency) or “SpdSrch (SETFREQ)” (start search command from the set frequency).

Build a sequence so that the FWD (REV) run command is input at the same time as the search command, or after the search command. If the run command is input before the search command, the search command

is not effective. Below is a timing diagram of the search command input:

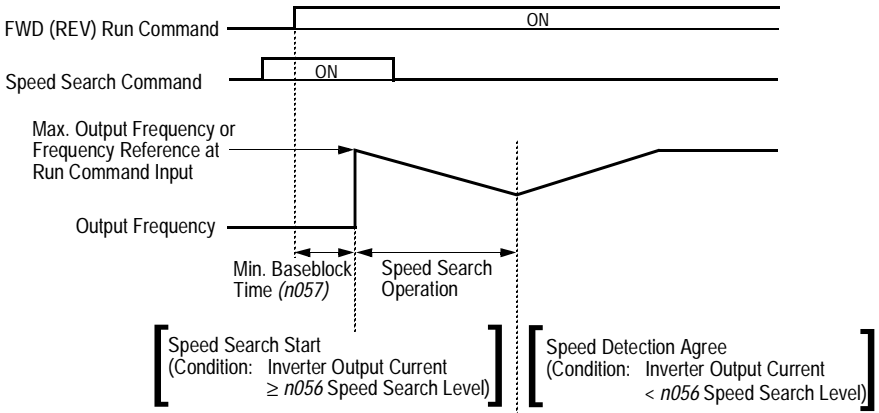

Figure 44 Search Command Input Timing Diagram

- DC Injection Braking at Start (*n068*, DCInj Current; *n070*, DCInj Time@Start)

This function restarts a coasting motor after first applying it with DC injection braking. DC injection braking time at start (*n070*) is set in units of 0.1 second. DC injection braking current is set in parameter *n068* in units of 1%. When parameter *n070* is set to “0”, DC injection braking is disabled and acceleration starts from the minimum output frequency.

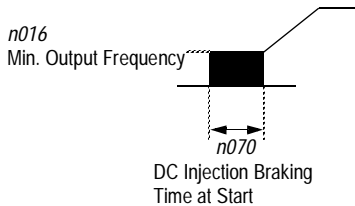

Figure 45 DC Injection Braking at Starting

V/f Pattern Adjustment (*n010*, V/f Selection)

Set the V/f pattern using parameter *n010* as described below. It may be necessary to change the V/f pattern when using a high-speed motor, or when special torque adjustment is required in the application.

- Set values:
- “60Hz Preset”: Fixed V/f pattern
 - “User defined V/f”: Custom V/f pattern can be set

Set the V/f pattern according to the following:

- n010 = “60Hz Preset” (Factory default value)
Set parameter n010 to “60Hz Preset” when a standard 50/60Hz, 230/460V motor is selected. This setting provides a standard linear V/Hz pattern. Parameters n011 through n017 cannot be adjusted.
- n010 = “User defined V/f” (Custom V/f pattern)
Set parameter n010 to “User defined V/f” when a variable torque pattern is required. Parameters n011 through n017 can then be adjusted manually to customize a special V/f pattern. The default settings for parameters n011 through n017 when n010 = “User defined V/f” comprise the standard variable torque pattern.

Be sure to satisfy the following conditions for setting parameters n011 to n017:
 $n016 \leq n014 < n013 \leq n011$

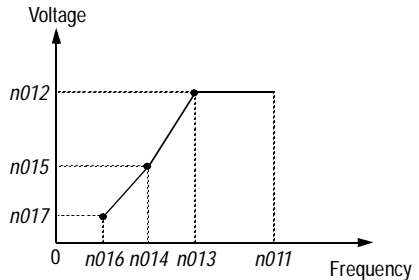

Figure 46 Custom V/f Pattern Setting

Parameter No.	Name	Unit	Setting Range	Factory Default (n010=60Hz Preset)	Factory Default (n010=User defined V/f)
n011	Maximum output frequency	0.1 Hz	50.0 to 400 Hz	60.0 Hz	60.0 Hz
n012	Maximum voltage	0.1 V	0.1 to 255 V *	230 V *	230 V *
n013	Maximum voltage output frequency (base frequency)	0.1 Hz	0.2 to 400 Hz	60.0 Hz	60.0 Hz
n014	Mid. output frequency	0.1 Hz	0.1 to 399.9 Hz	3.0 Hz	30.0 Hz
n015	Mid. output frequency voltage	0.1 V	0.1 to 255 V *	17.2 V *	57.5 V *
n016	Minimum output frequency	0.1 Hz	0.1 to 10.0 Hz	1.5 Hz	1.5 Hz

Parameter No.	Name	Unit	Setting Range	Factory Default (n010=60Hz Preset)	Factory Default (n010=User defined V/f)
n017	Minimum output frequency voltage	0.1 V	0.1 to 50.0 V *	11.5 V *	11.5 V *

* For 460V class units, the value is twice that of 230V class units.

Increasing the voltage in the V/f pattern increases motor torque, however, an excessive increase may cause:

- Inverter fault trips as a result of motor overexcitation
- Motor overheat or excessive vibration

Increase voltage gradually while checking the motor current.

Slip Compensation

The slip compensation feature allows better speed regulation to be obtained by adjusting the output frequency according to the changing load. This feature compensates for the slip of the motor.

Slip Compensation Gain (n107, Slip Comp Gain)

This parameter is used to input the slip of the motor. The setting is entered as a percent of base frequency (n013). The default value for n107 is 0.0% which disables this feature. To properly set the parameter, use the following equation:

Slip Compensation Primary Delay Time (n109, Slip Comp Delay)

This parameter sets how fast the inverter output frequency responds to changing loads. A long time will cause a sluggish response (a large momentary speed droop). A short time will cause a fast response (less speed droop). Too short of a time may cause instability.

3.4 INPUTS & OUTPUTS

Multi-function Input Signals (n036 to n040)

Multi-function contact input terminal S2 to S6 functions can be changed when necessary by setting parameters *n036* to *n040*, respectively. None of these parameters can receive a setting common with the other (no duplication).

- Terminal S2 function: set via parameter *n036*
- Terminal S3 function: set via parameter *n037*
- Terminal S4 function: set via parameter *n038*
- Terminal S5 function: set via parameter *n039*
- Terminal S6 function: set via parameter *n040*

Multi-function Input Signals				Ref. Page
LED Setting	LCD Setting	Description	Remarks	
0	Reverse RUN (2W)	Reverse run (2-wire sequence)	Only parameter <i>n036</i> can be set to this value.	79
1	FWD/REV Cmd (3W)	Fwd / Rev command (3-wire sequence)	Only parameter <i>n036</i> can be set to this value.	
2	Ext Fault (NO)	External fault (normally open)	Inverter stops at fault when external fault signal is input. Digital operator displays "EFX".	-
3	Ext Fault (NC)	External fault (normally closed)	Inverter stops at fault when external fault signal is input. Digital operator displays "EFX".	
4	Fault Reset	Fault reset	Resets fault. Fault reset is disabled during run command input.	-
5	LOCAL/REMOTE Sel	Local / Remote selection	—	79
6	COM/INV Sel	Serial com/inverter selection (Fref, RUN command)	—	79
7	STOP Cmd/Decel2 NO	Fast stop using Decel 2 (normally open)	Decelerates to stop by decel time 2 (<i>n021</i>) when fast stop is input.	-

8	STOP Cmd/Dec2 NC	Fast stop using Decel 2 (normally closed)	Decelerates to stop by decel time 2 (<i>n021</i>) when fast stop is input.	-
9	Master Fref Sel	Master freq. ref. selection (FV-open or FI-closed)	Master frequency reference input level (voltage input at "open", current input at "closed") can be selected.	-
10	Multi-Step Spd 1	Multi-step speed reference command 1	---	64
11	Multi-Step Spd 2	Multi-step speed reference command 2	---	
12	Not Used	Not used	---	-
13	JOG Command	Jog reference (<i>n030</i>)	---	59
14	Acc/Dec Switch	Accel / Decel time selection	---	49
15	Ext Baseblk (NO)	External baseblock (normally open)	Coasting signal. Motor starts coasting when the signal is input. Digital operator displays "bb" (blinking).	-
16	Ext Baseblk (NC)	External baseblock (normally closed)	Coasting signal. Motor starts coasting when the signal is input. Digital operator displays "bb" (blinking).	
17	SpdSrch (MAXFRO)	Speed search from maximum frequency	Speed search command signals.	74
18	SpdSrch (SETFRO)	Speed search from set frequency	Speed search command signals.	
19	Param Lockout	Parameter setting enable / disable	Permission or prohibition of constant setting from the digital operator or serial communication (setting disabled at "closed", enabled at "open") can be selected.	-
20	PID I Reset	PID integral value reset	---	67
21	PID Disable	PID control enable / disable	---	
22	Timer Start Cmd	Timer function	---	80
23	OH3 Input	External overheat alarm (OH3)	When this signal is input, the digital operator displays "OH3" (blinking). Inverter continues operation.	-
24	Ref Sample Hold	Analog reference sample hold command	Analog frequency reference is sampled at "closed" and held at "open".	80
25	KEB Cmd (NO)	Inertia ridthrough command (normally open)	---	---
26	KEB Cmd (NC)	Inertia ridthrough command (normally closed)	---	---
27	Hold Command	Accel / Decel hold command	---	---
28	PID Polarity Sel	Inverse PID enable / disable	---	---
29	UP/DOWN Cmd	UP/DOWN Command	Only parameter <i>n040</i> can be set to this value.	81

* 2 to 6 are displayed in _ corresponding to S2 to S6, respectively.

Factory settings: *n036* = "Reverse RUN (2W)", *n037* = "Ext Fault (NO)", *n038* = "Fault Reset", *n039* = "Multi-Step Spd 1", *n040* = "Multi-Step Spd 2"

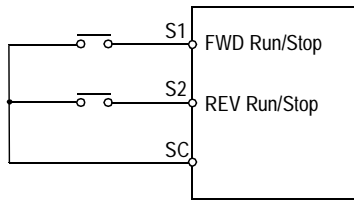

Figure 47a Terminal Function at 2-Wire Sequence Selection (setting: *n036*="Reverse RUN (2W)")

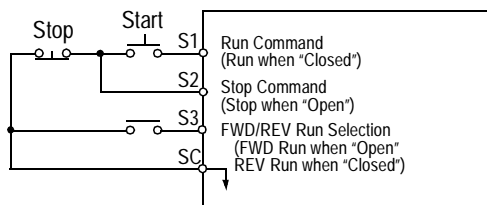

Figure 47b Terminal Function at 3-Wire Sequence Selection (setting: $n036="FWD/REV\ Cmd\ (3W)"$)

• **Local/Remote Selection (setting: “LOCAL/REMOTE Sel”)**

Selects whether the run command is received from the digital operator or the control circuit terminal. Local/Remote selection is available only while the inverter is stopped.

Open: Run according to the setting of operation mode selection ($n002$).

Closed: Frequency reference and run command from the digital operator.

Example: Set $n002$ to “SEQ=TRM REF=TRM”.

Open: Frequency reference from control circuit terminals FV & FI, and run command from control circuit terminals S1 and S2.

Closed: Frequency reference and run command from the digital operator.

• **Serial Communication/Control Circuit Terminal Selection (setting: “COM/INV Sel”)**

Selects operation reference by serial communication or by the control circuit terminal. This selection is available only during stop.

Open: run according to the setting of operation mode selection ($n002$).

Closed: Frequency reference and run command from serial communication.

Example: Set $n002$ to “SEQ=TRM REF=TRM”.

Open: Frequency reference from control circuit terminals FV & FI, and run command from control circuit terminals S1 and S2.

Closed: Frequency reference and run command from serial communication.

• **Timer Function (setting: “Timer Start Cmd”)**

The timer function is used in conjunction with the multi-function contact output (parameter $n041$ or $n042$ set to “Timer Output”).

When the timer function input is “closed” for longer than the ON-delay

timer (*n080*), the timer function output closes.

When the timer input is “open” for longer than the OFF-delay timer (*n081*), the timer function output opens.

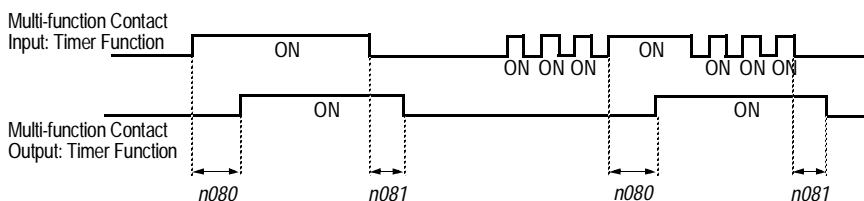

Figure 48 Timing Diagram of Timer Function

- Analog Reference Sample/Hold Selection (setting: “Ref Sample Hold”)**
 This feature allows a single analog signal to be used among multiple inverters to “sample and hold” separate speeds. Each inverter can be commanded to acknowledge the reference at different times. If the analog reference sample/hold input terminal is “closed” for 100ms or longer, the analog frequency reference is sampled; when it opens, the analog frequency reference is held.

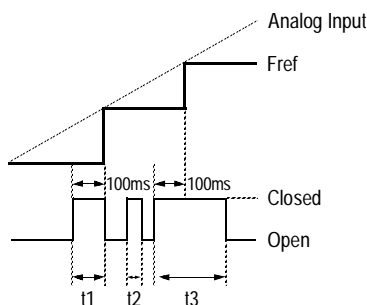

Figure 49 Sample/Hold Selection - Analog Reference

Note: t_1, t_3 - Reference is sampled once with an input closure of 100ms or longer.
 t_2 - Reference is not sampled with an input closure of less than 100ms.

- Up/Down Command (setting: *n040* = “Up/Down Control”)**
 With the FWD (REV) run command entered, a change in frequency is performed by inputting the Up or Down commands to control circuit terminals S5 and S6, so that operation can be performed at the desired speed. When the Down command is specified for terminal S6 by setting *n040*=“Up/Down Control”, any function set to terminal S5 via parameter *n039* becomes disabled; terminal S5 becomes an input terminal for the

Up command and terminal S6 an input terminal for the Down command.

Control Circuit Terminal S5 (UP command)	Closed	Open	Open	Closed
Control Circuit Terminal S6 (DOWN command)	Open	Closed	Open	Closed
Operation Status	Accel	Decel	Hold	Hold

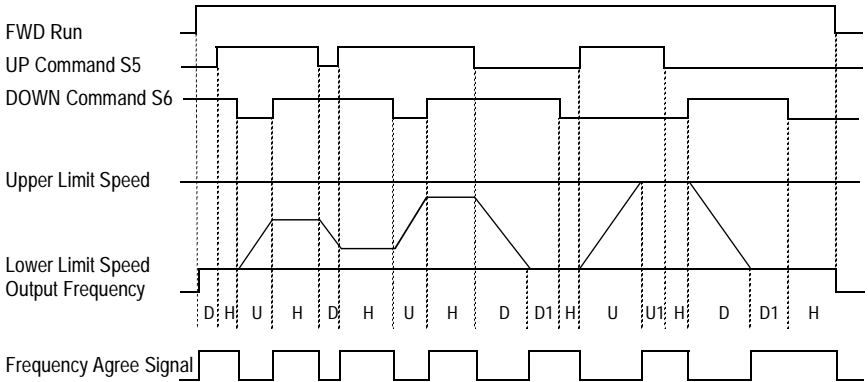

- U: Up (accelerating) status
- D: Down (decelerating) status
- H: Hold (constant speed) status
- UI: Up status, with clamping at upper limit speed
- DI: Down status, with clamping at lower limit speed

Figure 50 Timing Diagram of UP/DOWN Command Input

Notes:

- 1) When the UP/DOWN command is selected, the upper limit speed is set regardless of frequency reference.
Upper limit speed = Maximum output frequency (n011)
× Frequency reference upper limit (n031) /100
- 2) The lower limit value is either the analog frequency from control circuit terminals FV or FI, or the frequency reference lower limit (n032), whichever is larger.
- 3) When the FWD (REV) run command is input, operation starts at the lower limit speed without an UP/DOWN command.
- 4) If the jog frequency reference is input while the drive is running by the UP/DOWN command, the jog frequency reference has priority.

Analog Input Signals

Master Analog Input Selection (n043, Analog Input Sel)

To input the master frequency reference from the control circuit terminal, use terminal FV (0 to 10V) or terminal FI (4 to 20mA), by setting parameter n043.

LED Setting	LCD Setting	Master Frequency Reference Terminal	Input Level
0	FV=MSTR FI=AUX	FV (factory default)	0 to 10V input

LED Setting	LCD Setting	Master Frequency Reference Terminal	Input Level
1	FV=AUX FI=MSTR	FI	4 to 20mA input

- **Auxiliary Analog Input Selection (*n044, Terminal FI Sel*)**
From the factory, terminal FI is set to accept a 4-20mA signal. To change the control circuit terminal FI input level from current to voltage, set parameter *n044* according to the table below, and be sure to cut the “J1” jumper on the control PCB. The J1 jumper is located near terminal FI on the control PCB.

LED Setting	LCD Setting	Input Level
0 *	0-10 VDC	0 to 10V input
1	4-20 mA	4 to 20mA input (<i>factory default</i>)

* To set parameter *n044* to “0”, cut jumper J1 on the inverter control PCB board.

- **Frequency Reference Retention (*n045, MOP Ref Memory*)**
Effective when UP/DOWN or Sample/Hold commands are selected for multi-function contact inputs. To retain the held frequency reference at power OFF, set parameter *n045* to “Memorize Fref”. When *n045*=“Memorize Fref”, the last sampled/held reference will be memorized during power down. When power is re-applied, a run command will run the inverter at this previous speed. When *n045*=“Not Memorized”, the last sampled/held frequency will be lost at power down. Upon power-up, a new reference will need to be sampled.

LED Setting	LCD Setting	Description
0	Memorize Fref	Held frequency retained in frequency reference 1 - <i>n024 (factory default)</i>
1	Not Memorized	Not retained

- **Operation Method for Frequency Reference Loss Detection (*n046, Ref Loss Detect*)**
Selects the frequency reference if the frequency reference from the control circuit terminal decreases rapidly (lost signal).

LED Setting	LCD Setting	Description
0	Not Detected	Detection disabled (<i>factory default</i>)
1	RUN @ <i>n047</i> Fref	Detection enabled, continue to run at <i>n047</i> value × previous reference.

If the frequency reference decreases by 90% within 400ms (when detection is enabled), operation continues at reference equal to the *n047* value × previous reference.

Multi-function Output Signals (*n041, Terminal MA Sel;* *n042, Terminal M1 Sel*)

Multi-function output terminal MA, MB and M1 functions can be changed when necessary by setting parameters *n041* and *n042*.

- Terminal MA and MB functions: set via *n041*
- Terminal M1 functions: set via *n042*

Factory defaults: *n041* = “Fault”, *n042* = “During Running”

Multi-function Output Signals				Ref. Page
LED Setting	LCD Setting	Description	Remarks	
0	Fault	Fault	*Closed when inverter fault occurs.	-
1	During Running	During running	*Closed when either FWD or REV run command is input or when the inverter outputs voltage.	-
2	At Speed	Frequency agree	-	84
3	At Desired Speed	Desired frequency agree	-	84
4	Freq Detection 1	Frequency detection	-	57
5	Freq Detection 2	Frequency detection	-	57
6	OverTrq Det (NO)	Overtorque detection (N.O. contact)	-	73
7	OverTrq Det (NC)	Overtorque detection (N.C. contact)	-	73
8	BaseBlocked	During baseblock	*Closed when inverter output shuts OFF.	-
9	Operation Mode	Operation mode	*Closed* when run command or frequency reference from digital operator is selected.	-
10	Ready	Inverter operation ready	*Closed* when no inverter fault does not occur and the inverter can be operated.	-
11	Timer Output	Timer function	-	80
12	Auto-Restarting	Automatic restart	*Closed* during fault retry operation.	51
13	OL Pre-Alarm	OL pre-alarm	Outputs an alarm before inverter and motor overload protection are enabled. Pre-alarm level is 150% for 48 sec for the inverter and more than 80% of the overload protection time for the motor.	-
14	Freq Ref Loss	Frequency reference loss	Closes a contact when detecting a loss of reference condition.(See page 82 for <i>n046</i>).	82
15	Set By Com Cntl	Output from serial communication	Activates contact output independently from inverter operation by a command from serial communication (MODBUS).	-
16	PID Fdbk Loss	PID feedback loss	Detects a rapid decrease in feedback and outputs a contact when the PID control mode is set. Detects when the feedback value decreases less than the detection level (<i>n091</i>) for longer than the feedback loss detection delay time (<i>n092</i>); the inverter continues operation.	47
17	OH1 Alarm	OH1 alarm	*Closed* during heat sink overtemperature (digital operator displays *OH1* blinking).	-

Frequency Agree (setting: “At Speed”)

See Figure 51 below for an example of selecting the frequency agree sig-

nal as the function of output terminals MA, MB or M1.

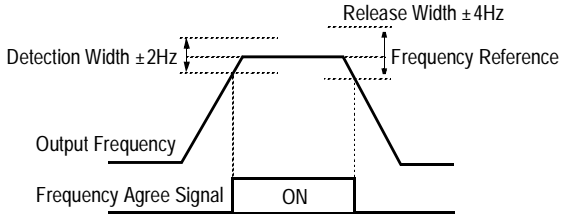

Figure 51 Example of Frequency Agree Signal (setting: "At Speed")

Desired Frequency Agree (setting: "At Desired Speed")

See Figure 52 below for an example of selecting the desired frequency agree signal as the function of output terminals MA, MB or M1.

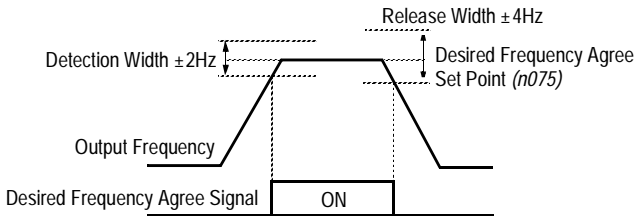

Figure 52 Example of Desired Frequency Agree Signal (setting: "At Desired Speed")

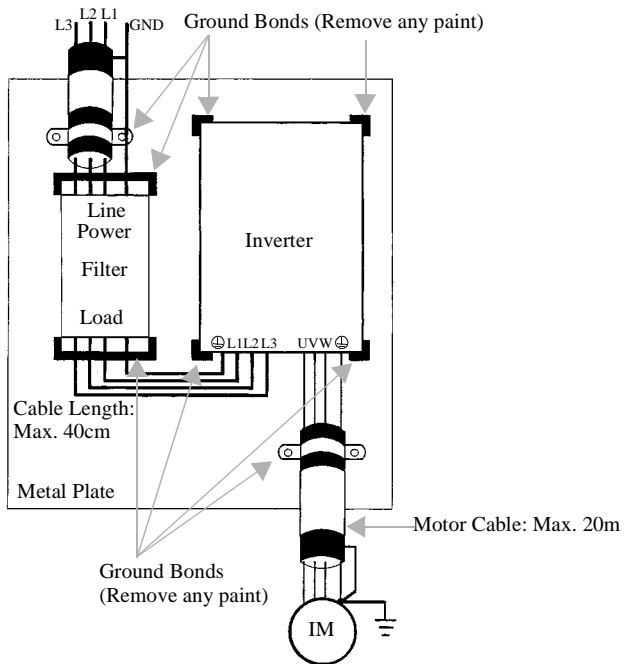

Fig. 12 Installation of Line Filter and Inverter (Models CIMR-P5U 40P4 to 4015)

