



EUROTHERM
DRIVES

EASYCOM



英国欧陆512C/514C直流调速器

使用说明书

(4-32A, 2/4象限运行)



一级代理商:

广州亿控自动化设备有限公司

销售热线: 020-38460215 38460521 38460561

传 真: 020-38460527

技术服务: 020-33186107

网址: www.gzeasycom.com

Emai: gzeasycom@21cn.com

地址: 广州市天河北路567号芳草园A1-11F1



EUROTHERM
DRIVES

512C Series

Product Manual

HA389196 Issue 7

© Copyright Eurotherm Drives Limited 2001

All rights strictly reserved. No part of this document may be stored in a retrieval system, or transmitted in any form or by any means to persons not employed by a Eurotherm group company without written permission from Eurotherm Drives Ltd.

Although every effort has been taken to ensure the accuracy of this document it may be necessary, without notice, to make amendments or correct omissions. Eurotherm Drives cannot accept responsibility for damage, injury, or expenses resulting therefrom.

WARRANTY

Eurotherm Drives warrants the goods against defects in design, materials and workmanship for the period of 12 months from the date of delivery on the terms detailed in Eurotherm Drives Standard Conditions of Sale IA058393C.

Eurotherm Drives reserves the right to change the content and product specification without notice.

Safety Information



Requirements

IMPORTANT: Please read this information BEFORE installing the equipment.

Intended Users

This manual is to be made available to all persons who are required to install, configure or service equipment described herein, or any other associated operation.

The information given is intended to highlight safety issues, and to enable the user to obtain maximum benefit from the equipment.

Complete the following table for future reference detailing how the unit is to be installed and used.

INSTALLATION DETAILS	
Serial Number <i>(see product label)</i>	
Where installed <i>(for your own information)</i>	
Unit used as a: <i>(refer to Certification for the Inverter)</i>	<input type="checkbox"/> Component <input type="checkbox"/> Relevant Apparatus
Unit fitted:	<input type="checkbox"/> Enclosure

Application Area

The equipment described is intended for industrial motor speed control utilising DC Shunt Wound or DC Permanent Magnet Motors.

Personnel

Installation, operation and maintenance of the equipment should be carried out by qualified personnel. A qualified person is someone who is technically competent and familiar with all safety information and established safety practices; with the installation process, operation and maintenance of this equipment; and with all the hazards involved.



Hazards

WARNING!

This equipment can endanger life through rotating machinery and high voltages. Failure to observe the following will constitute an ELECTRICAL SHOCK HAZARD.

- The equipment must be **permanently earthed** due to the high earth leakage current.
- The drive motor must be connected to an appropriate safety earth.
- Never perform high voltage resistance checks on the wiring without first disconnecting the drive from the circuit being tested.
- When replacing a drive in an application and before returning to use, it is essential that all user defined parameters for the product's operation are correctly installed.
- This equipment contains electrostatic discharge (ESD) sensitive parts. Observe static control precautions when handling, installing and servicing this product.

IMPORTANT: Metal parts may reach a temperature of 90 degrees centigrade in operation.

Application Risk

The specifications, processes and circuitry described herein are for guidance only and may need to be adapted to the user's specific application.

Eurotherm Drives does not guarantee the suitability of the equipment described in this Manual for individual applications.

Risk Assessment

Under fault conditions, power loss or other operating conditions not intended, the equipment may not operate as specified. In particular:

- The motor speed may not be controlled
- The direction of rotation of the motor may not be controlled
- The motor may be energised

Guards

The user must provide guarding and /or additional safety systems to prevent risk of injury and electric shock.

Protective Insulation

- All control and signal terminals are SELV, i.e. protected by double insulation. Ensure all wiring is rated for the highest system voltage.

Note: *Thermal sensors contained within the motor must be double insulated.*

- All exposed metalwork in the Inverter is protected by basic insulation and bonding to a safety earth.

RCDs

These are not recommended for use with this product but ,where their use is mandatory, only Type B RCDs should be used.

Contents

<i>Contents</i>	<i>Page</i>
Chapter 1 GETTING STARTED	
Introduction	1-1
Optional Equipment.....	1-1
Equipment Inspection	1-1
About this Manual	1-2
Initial Steps.....	1-2
How the Manual is Organised.....	1-2
Chapter 2 AN OVERVIEW OF THE CONVERTER	
Component Identification	2-1
Understanding the Product Code	2-2
Chapter 3 INSTALLING THE CONVERTER	
Mechanical Installation	3-1
Mounting the Converter.....	3-2
• Filter Installation.....	3-2
Electrical Installation	3-4
Recommendations.....	3-4
Chapter 4 OPERATING THE CONVERTER	
Pre-Installation Planning	4-1
Basic Wiring Diagrams.....	4-1
• Basic Connection.....	4-1
Setting-Up & Commissioning	4-2
Option Switches.....	4-2
• Speed Feedback Scaling.....	4-2
• Speed Feedback Source.....	4-2
• Zero Output Source.....	4-2
• Current Scaling.....	4-2
• Current Motor Scaling.....	4-3
Potentiometers.....	4-3
Basic Setting-Up Procedure	4-4
• Controller.....	4-4
• Motor.....	4-4
Preparation.....	4-4
• Machine.....	4-4
• Controller.....	4-4
• Power-Up.....	4-5

Contents

<i>Contents</i>	<i>Page</i>
Chapter 5 LED INDICATIONS	
LED Indications.....	5-1
Chapter 6 TERMINAL DESCRIPTIONS	
Terminal Descriptions	6-1
Control Terminals	6-1
Power Terminals	6-2
Field Terminals (Auxiliary Supply).....	6-2
Chapter 7 FAULT FINDING	
Troubleshooting	7-1
Chapter 8 ROUTINE MAINTENANCE AND REPAIR	
Routine Maintenance	8-1
Repair.....	8-1
Returning the Unit to Eurotherm Drives.....	8-1
Disposal	8-1
Chapter 9 REPLACEMENT OF 512 WITH 512C	
512C/512 Terminal Differences	9-1
Functional Differences 512C & 512	9-2
Chapter 10 BLOCK DIAGRAM	
Block Diagram	10-1
Chapter 11 TECHNICAL SPECIFICATIONS	
Environmental Requirements.....	11-1
Operating Conditions.....	11-1
• Terminal Tightening Torques	11-2
Electrical Ratings	11-3
Chapter 12 CERTIFICATION FOR THE CONVERTER	
EMC and the 'CE' Mark.....	12-1
'CE' EMC Responsibility.....	12-1
Special Considerations for Installations Requiring Compliance with UL Standards.....	12-3
Certificates.....	12-4

GETTING STARTED

Introduction

The 512C converter is intended for use in an Industrial Environment, it should be mounted within an enclosure which provides protection to the converter and the user.

The converter should be permanently earthed at the terminals provided.

The 512C converter is suitable for the control of Permanent Magnet and Shunt Wound DC Motors.

The converters are designed to operate from a single phase ac mains supply in the range of 110Vac to 415Vac at 50 or 60Hz. A simple transformer tap arrangement allows the converter to be programmed to suit the applied voltage.

The Speed of the DC Motor is controlled using a linear closed loop system with a feedback signal from either tachogenerator or armature voltage, the feedback source being switch selectable.

A current loop within the speed loop always ensures that controlled levels of current are applied to the motor, actual levels being scaleable via programmable switches.

Motor protection is provided by a Stall detection circuit which will remove current from the motor after approximately 60 seconds.

Converter protection is provided by a Instantaneous Overcurrent trip circuit overriding control in the event of a Short Circuit.

Optional Equipment

Item	Part Number
UL Compression Lug Kits <i>See page 12.3 for more information.</i>	LA389745U016 LA389745U032
EMC Installation Guidelines for Modules and Systems <i>A Eurotherm Drives application manual detailing EMC requirements</i>	HA388879
External AC Supply (RFI) Filter <i>For 512C units without internal filters, on cable runs in excess of 25 metres</i>	Refer to Chapter 3 for Part Numbers
Fuse Isolator Kit <i>High speed semi-conductor fuses are recommended.</i>	See table 11.1 for part numbers.

Table 1-1 Optional Equipment

Equipment Inspection

- Check for signs of transit damage
- Check the product code on the rating label conforms to your requirement.

If the unit is not being installed immediately, store the unit in a well-ventilated place away from high temperatures, humidity, dust, or metal particles.

Refer to Chapter 2: "An Overview of the Converter" to check the rating label/product code. Refer to Chapter 8: "Routine Maintenance and Repair" for information on returning damaged goods.

Refer to Chapter 11: "Technical Specifications" - Environmental Details for the storage temperature.

About this Manual

This manual is intended for use by the installer of the 512C converter. It assumes a reasonable level of understanding in these disciplines.

Note: *Please read all Safety Information before proceeding with the installation and operation of this unit.*

Enter the “Model No” from the rating label into the table at the front of this manual. It is important that you pass this manual on to any new user of this unit.

This manual is for the following models from the 512C Converter Series:

512C/04	4A DC Full Load Current
512C/08	8A DC Full Load Current
512C/16	16A DC Full Load Current
512C/32	32A DC Full Load Current

Initial Steps

Use the manual to help you plan the following:

Installation

Know your requirements:

- certification requirements, CE/UL/CUL conformance
- mount in an enclosure
- conformance with local installation requirements
- supply and cabling requirements

How the Manual is Organised

The manual is divided into chapters and paragraphs. Page numbering restarts with every chapter, i.e. 5-3 is Chapter 5, page 3.

AN OVERVIEW OF THE CONVERTER

Component Identification

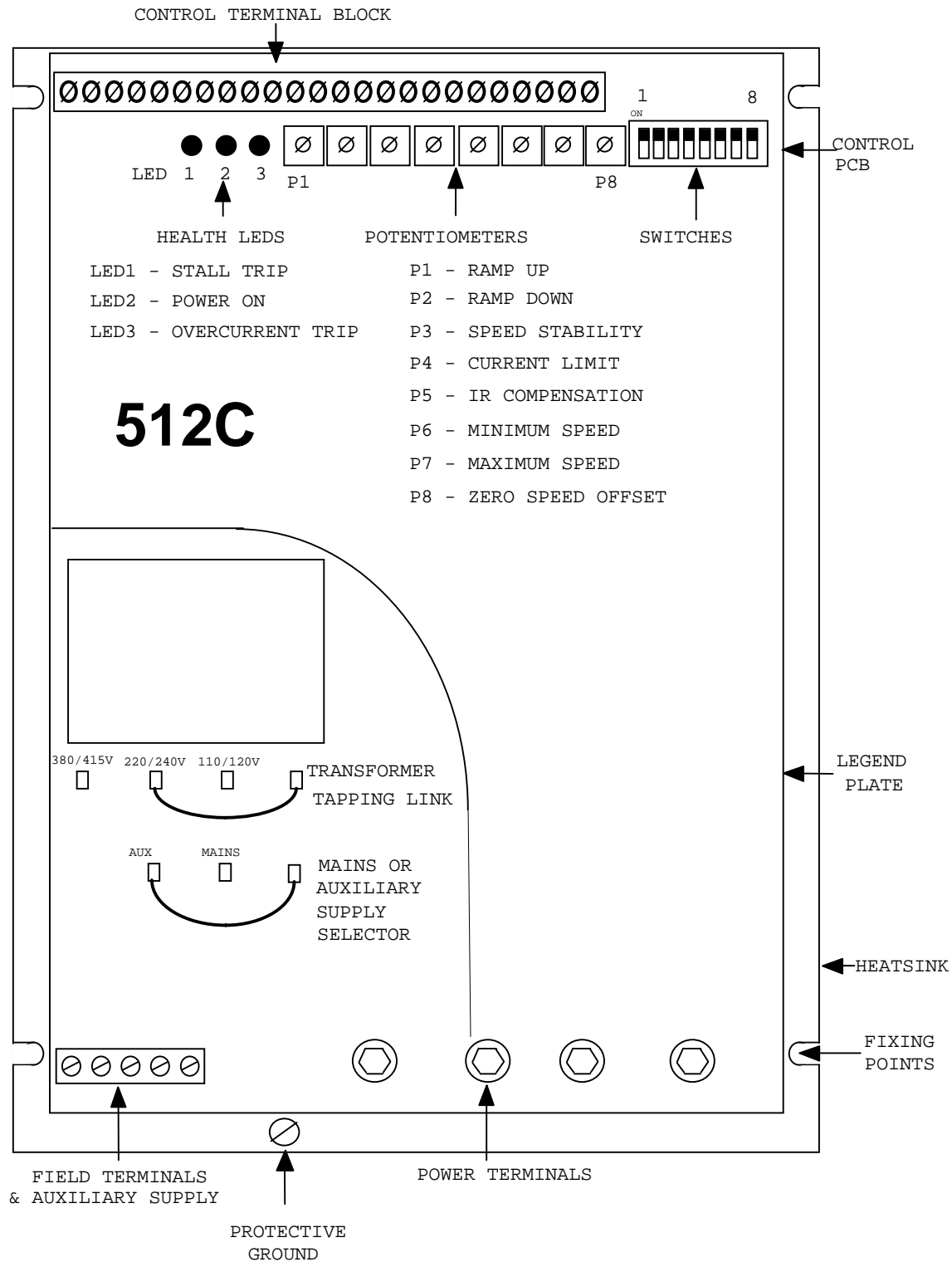

Figure 2-1 View of Component Parts

2-2 An Overview of the Converter

Control Features

Speed Control	Control Action	Closed Loop with Proportional Integral Control and Adjustable Stability		
	Speed Feedback	Armature Voltage	Tachogenerator	
	100% Load Regulation	2 % Typical	0.1 % Typical	
	Maximum Torque/Speed Range	20:1	100:1	
	Overload	150% for 60 seconds.		
Torque Control	Control Action	Closed Loop with Proportional Integral Control		
	Accuracy	2 %		
	Overspeed	Inherent		
	Overload	None 100% Continuous (consideration must be given to motor when operating at low speed)		
Inputs/Outputs	Analogue Inputs	Setpoint Ramp	0 to +10V	100Kohm
		Auxiliary Speed Setpoint	0 to +10V	100Kohm
		Current Limit	0 to +7.5V	50Kohm
		Tachogenerator Input	0 to +350Vdc	110Kohm
	Analogue Outputs	Speed	0 to +10V	5mA
		Current (SW8 Off)	0 to +5V (0 to Idc)	5mA
		Current (SW8 On)	0 to +5V (0 to Ical)	5mA
		Setpoint Ramp	0 to +10V	5mA
		Total Setpoint	0 to +10V	5mA
		+10V Reference	+10V	5mA
		-10V Reference	-10V	5mA
	Digital Inputs	Run	+10 to +24V	100Kohm
		Stall Override	+10	100Kohm
	Digital Outputs	Health	+24V	50mA Source
		Zero Speed or Setpoint	+24V	50mA Source

Understanding the Product Code

The unit is fully identified using a five block alphanumeric code which records how the Converter was calibrated, and its various settings when despatched from the factory.

The Product Code appears as the “Model No.”. Each block of the Product Code is identified as below:

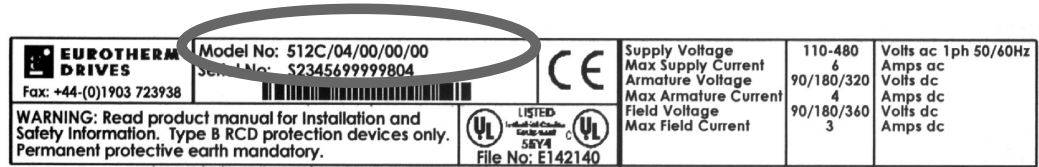

Block No.	Variable	Description
1	512C	Generic product
2	XX	Two numbers specifying the current output, for example: 04 = 4Amp 08 = 8Amp 16 = 16Amp 32 = 32Amp
3	XX	Two numbers specifying mechanical package including livery and mechanical package style, and any option installed over and above the standard features of the product: Two numbers Livery 00 Standard Eurotherm Drives livery 01-99 Defined customer liveries
4	XX	Two numbers specifying the cover: IP00 Open Frame
5	XX	Two numbers specifying the special options: 00 = Standard 01 - 99 = Documented Special Options

3-1 Installing the Converter

INSTALLING THE CONVERTER

IMPORTANT: Read Chapter 12: "Certification for the Converter" before installing this unit.

Mechanical Installation

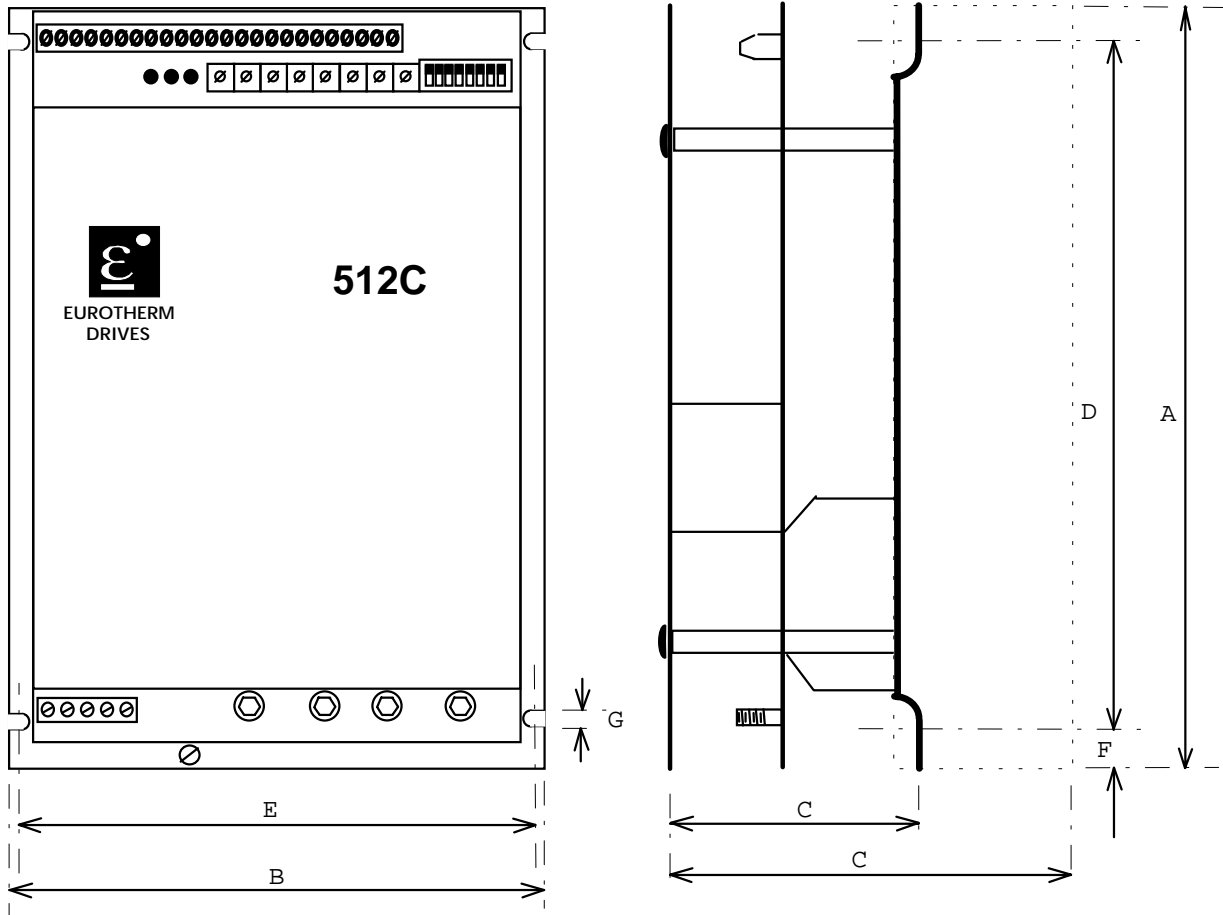

PRODUCT	OVERALL DIMENSIONS			FIXING CENTRES		SIZE	SLOT DETAIL	
	A	B	C	D	E		F	G
512C/04	240mm	160mm	90mm	210mm	148mm	M6	15mm	7mm
512C/08	240mm	160mm	90mm	210mm	148mm	M6	15mm	7mm
512C/16	240mm	160mm	90mm	210mm	148mm	M6	15mm	7mm
512C/32	240mm	160mm	130mm	210mm	148mm	M6	15mm	7mm

Table 3.1 Product Dimensions

Mounting the Converter

Before connecting AC supplies to this equipment:

- Ensure good airflow over the heatsink. Maintain clearance of 75mm above and below controller. For safety maintain a clearance of 20mm at the sides of the controller.
- Operating temperature range does not exceed 0 to +40°C.
- Controller is used in a Pollution Degree 2 environment.
- Avoid vibration.

Filter Installation

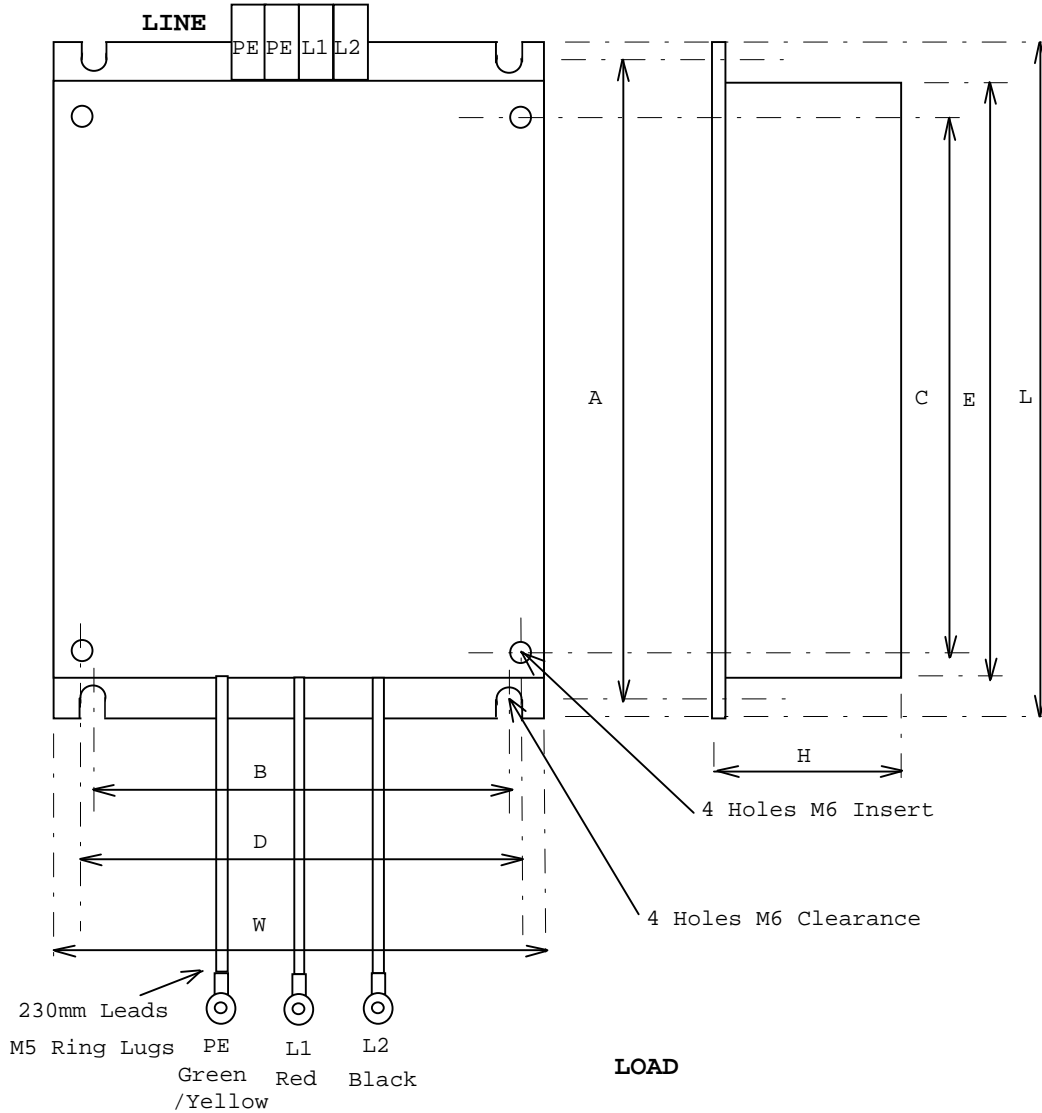

Product	Filter	Watt Loss	Overall Dimensions				Fixing Centres		Product Fixing		Terminal
			L	W	H	E	A	B	C	D	
512C/04	CO389113	18W	264	165	45	240	253	120	210	148	4mm ²
512C/08	CO389113	18W	264	165	45	240	253	120	210	148	4mm ²
512C/16	CO389113	18W	264	165	45	240	253	120	210	148	4mm ²
512C/32	CO389114	36W	264	165	70	240	253	120	210	148	6mm ²

Table 3.2 Filter Installation Information

3-3 Installing the Converter

MOTOR

- Ensure motor is mechanically secure and mounted according to manufacturers specifications and practice.
- Inspect brush gear, ensure commutator is in good condition and brushes are free to move in brush box and in good condition.
- Check obstructions in motor vents to maintain cooling air path.
- Ensure motor choke (if specified) is correctly wired.
- Ensure motor is free to rotate and that pulleys and couplings are correctly aligned.
- Ensure transit damage has not occurred to motor windings or connections. Disconnect the controller before carrying out electrical measurement e.g. insulation resistance.

	512C/04	512C/08	512C/16	512C/32
Overall Width	160mm			
Overall Height	240mm			
Overall Depth	90mm	90mm	90mm	130mm
Weight	1.5Kg	1.5Kg	1.6Kg	2.9Kg
Airflow Clearance	75mm above and below			
Mounting Centres	210mm vertical x 148mm horizontal			
Control Terminals	Screw Terminals will accept 2.5mm ² stranded wire. Terminal Tightening Torque 0.6 Nm, 4.5 lbf-in			
Field Terminals	Screw terminals will accept 4mm ² stranded wire. Terminal Tightening Torque 0.6 Nm, 4.5 lbf-in			
Power Terminals	M5 Studs with Clamp. Terminal Tightening Torque 2.7 Nm, 24 lbf-in			
Earth Terminals 	M5 Cheese Head Screw. Terminal Tightening Torque 7.1 Nm, 63 lbf-in			

Table 3.3 Motor Information

Electrical Installation

Recommendations

- Although the controller is designed to provide double or reinforced insulation between the user and bare live parts, it is recommended that the “0v/Signal Ground” is earthed. Where a number of controllers are used in a system the “0v/Signal Ground” terminals should be connected together and earthed at one point.
- The controller is designed for armature current form factor of 1.5 or less. It is recommended that a armature choke be fitted where a form factor of less than 1.5 current cannot be guaranteed.
- Due to the earth leakage currents the controller and filter should be **permanently earthed**. This can be achieved by either connecting two earthing conductors of the required value, see table 11.1, or connecting one earthing conductor of at least 10mm².

IMPORTANT: The Converter fitted with an internal or external ac supply EMC filter is only suitable for earth referenced supplies (TN).

OPERATING THE CONVERTER

Pre-Installation Planning

Basic Wiring Diagrams

Basic Connection

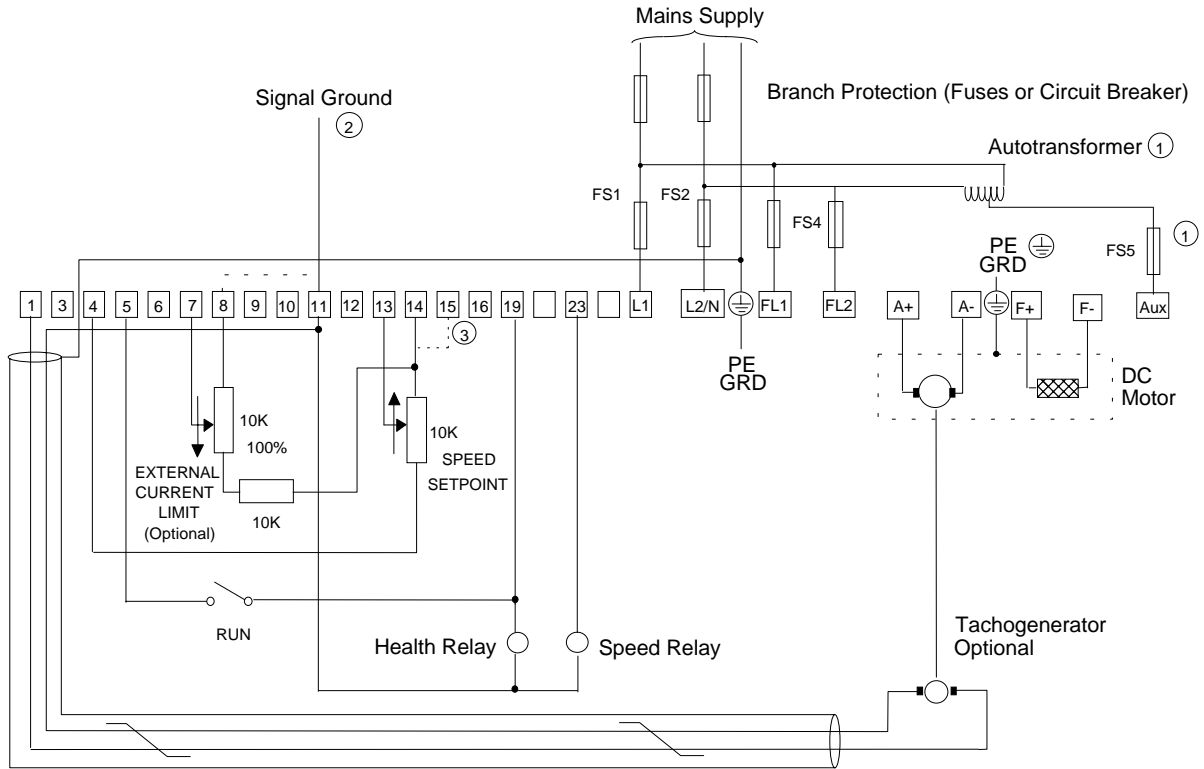

- ① Optional Autotransformer for non standard mains voltages.
- ② It is recommended that the “0V/common” be connected to protective earth/ground for safety reasons. In a system comprising of more than one controller, the “0V/common” signals should be connected together and joined to protective earth/ground at **one** point only.
- ③ Stall override link between terminals 14 and 15 required when using controller in current control.

Setting-Up & Commissioning

Option Switches

Speed Feedback Scaling

SW1	SW2	FEEDBACK VOLTAGE	
OFF	ON	10 - 25V	USE P7 TO TRIM
ON	ON	25 - 75V	MAXIMUM SPEED
OFF	OFF	75 - 125V	TO REQUIRED
ON	OFF	125 - 325V	VALUE

Table 4.1 Full speed tachogenerator/armature feedback voltage.

Example:

- (a) Customer wishes to run motor at 1500rpm with a 60V/1000rpm tachogenerator.
Feedback voltage = 90V
From Table 4.1 set SW1 OFF SW2 OFF adjust P7 to give desired speed.
- (b) Customer wishes to run motor at 2000rpm with 320V armature.
Feedback voltage = 320V
From Table 4.1 set SW1 ON SW2 OFF adjust P7 to give desired speed.

Note: It is necessary to set these switches for both tachogenerator and armature voltage feedback.

Speed Feedback Source

- SW3 (OFF) Tachogenerator Controller uses Tachogenerator Feedback for Speed Control.
- SW3 (ON) Armature Voltage Controller uses Armature Voltage Feedback for Speed Control.

Zero Output Source

- SW4 (OFF) Zero Output Zero Setpoint Output
- SW4 (ON) Zero Output Zero Speed Output

Current Scaling

SW5	SW6	SW7	FULL LOAD CURRENT CONTROLLER OPTION			
			04	08	16	32
OFF	OFF	OFF	½A	1A *	2A *	4A *
ON	OFF	OFF	1A	2A *	4A *	8A *
OFF	ON	OFF	1½A	3A *	6A *	12A *
ON	ON	OFF	2A	4A *	8A *	16A *
OFF	OFF	ON	2½A	5A	10A	20A
ON	OFF	ON	3A	6A	12A	24A
OFF	ON	ON	3½A	7A	14A	28A
ON	ON	ON	4A	8A	16A	32A

Table 4.2 Current Calibration

(* see note on next page)

Example: Customer wishes to run 14 Amp Motor.

Option 1 Using 512/16 - From table 4.2 set SW7 ON, SW6 ON, SW5 OFF Ia = 14 Amp

Option 2 Using 512/32 From table 4.2 set SW7 OFF, SW6 ON, SW5 ON - Ical = 16 Amp
Turn down I Limit (P4) to give 14 Amps

4-3 Operating the Converter

Note: * 8 Amp, 16 Amp and 32 Amp controllers can be scaled to currents of 4 Amp, 8 Amp or 16 Amp or less but it is recommended that lower current controllers be used in these circumstances.

Current Motor Scaling

SW8 (OFF) Current Meter Buffered Current Meter Output
 5V Equivalent to 100% of Controller Current Rating.
 i.e. 4 Amp on 512C/04
 8 Amp on 512C/08
 16 Amp on 512C/16
 32 Amp on 512C/32

SW8 (ON) Current Meter Buffered Current Meter Output
 5V Equivalent to 100% of Calibrated Current Rating.
 For Example 512C/16 SW5-ON,SW6-ON,SW7-OFF
 Calibrated Current = 8 Amp therefore 5V = 8amp.

Potentiometers

P1	Ramp Up Rate	Rotate Clockwise for Faster Acceleration to Set Speed. (Linear :- 1 to 40 seconds)	Same as 512
P2	Ramp Down Rate	Rotate Clockwise for Faster Deceleration to Set Speed. (Linear :- 1 to 40 seconds)	Same as 512
P3	Speed Loop Stability	Optimises Speed Loop Stability. (Excessive adjustment may lead to instability)	Same as 512
P4	I Limit	Rotate Clockwise to increase Maximum Output Current. With no additional connection to Torque / Current Limit Terminal T7, the Upper Limit is 110%. To achieve the 150% maximum connect T7 to +7.5V.	Same as 512
P5	IR Compensation	Optimises speed regulation against load change when using Armature Voltage Feedback. Rotate Clockwise to increase compensation and reduce regulation.(Excess adjustment may lead to instability) Turn Anti-clockwise when Tachogenerator Feedback used.	Same as 512
P6	Minimum Speed	Controls Minimum Motor Speed /Setpoint when Speed Setpoint Potentiometer connected to Terminal 4. Rotate Clockwise to increase Minimum Speed / Setpoint. (Approximately 30% adjustment when using 10K ohm Speed Setpoint Potentiometer.)	Same as 512
P7	Maximum Speed	Controls Maximum Motor Speed. Rotate clockwise to increase maximum speed.	Same as 512
P8	Zero Speed Offset	Adjusts Zero or Minimum Speed for Zero Speed Setpoint.	New Feature

Table 4.3 Customer Adjustments.

Basic Setting-Up Procedure

Caution BEFORE ATTEMPTING TO CONNECT POWER

Controller

Check:-

- the Main power supply voltage is within the operating range of the controller.
- the Armature voltage and current ratings are compatible with controller supplied.
- the Field voltage and current ratings are suitable.
- All external wiring circuits are correct, i.e.:-

Power connections

Control connections

Motor connections

Note: *Completely disconnect the controller before point to point checking with a buzzer or when checking insulation with a megger.*

- For damage to equipment.
- For loose ends, clippings, drilling swarf etc., lodged in the drive or ancillary equipment.

Motor

- Inspect the motor, in particular the commutator for any extraneous matter. If an air supply is available, it is recommended to blow over the commutator.
- Check the brushes are properly seated and that the brush spring tension is adequate.
- If possible check that the motor (and vent fan if fitted) can be turned freely by hand.

Preparation

Machine

Check:-

- That rotation of the motor in either direction will not cause damage.
- That nobody else is working on another part of the equipment that will be affected by powering up.
- That other equipment will not be adversely affected by powering up.

Controller

- Prevent application of the main power supply by removal of the supply fuses.
- Disconnect the load from the motor shaft if possible.
- If there is any doubt as to the integrity of a particular installation, insert a high wattage resistor (i.e. fire bar elements) in series with the motor armature.
- If it is possible to rotate the motor, and tachogenerator feedback is in use, check that forward rotation results in positive tacho feedback, i.e. terminal 1 is positive with respect to terminal 8 or 11.

4-5 Operating the Converter

- Check switch selection
SW1) Speed Range (see table 4.1)
SW2)
SW3 Tachogenerator / VA (see switch options on page 4.1)
SW4 Zero Speed / Zero Setpoint (see switch options on page 4.1)
SW5)
SW6) Current Calibration (see table 4.2)
SW7)
SW8 Controller / Calibrated Armature Current Meter Output

- Check all pots are set thus:-
- Potentiometers P1, P2, P4, P5, P6, P7 fully Anticlockwise.
- Potentiometers P3 & P8 mid position.
- Check transformer supply tap is compatible with the Mains supply voltage. †
- Check external run contacts are open.
- Check external set points are all zero.

† If not use the Auxiliary Supply input at compatible voltage and apply Mains Power at required level up to 460Vac.

Power-Up

Once all the proceeding steps are completed the supply fuses may be replaced and power applied to the drive. Although fairly general, the following assumes the system to be a simple speed control drive and motor.

At switch on the “Power ON” LED should illuminate (LED 2 see Page 5.1)

Close RUN contact and give the drive a small speed demand (approximately 10%) and increase the external auxiliary current limit (if used) to 50%. Slowly increase the main current limit (P4) until the motor starts to rotate. If the motor increases speed to more than 10% of full speed immediately turn current limit (P4) fully anticlockwise and/or remove Run signal (terminal 5) immediately.

If overspeeding occurred while using a tachogenerator for speed feedback correct the wiring as follows:

Problem	Action
Direction correct but overspeeding:	Reverse tacho polarity only
Direction incorrect and overspeeding:	Reverse field polarity only

When armature voltage feedback is used for speed feedback it is direction insensitive and overspeeding due to incorrect feedback cannot occur, excess speed is probably due to incorrect feedback scaling, check setting of switches SW1 and SW2.

If the motor runs under control but in the wrong direction correct as follows either:-

Armature Control	Reverse Field polarity
Tachogenerator Control	Reverse Field & Tachogenerator Polarity

- Increase speed demand to maximum and check armature voltage does not exceed motor rating, adjust by P7 to give desired motor speed.
- Set Minimum Speed by adjusting by P6 to the required level. (note P6 is only active if the speed setting potentiometer is wired to terminal T4.)
- Set the Ramp Up time (P1) and Ramp Down time (P2) to the required rates.
- With armature voltage feedback, speed droop will occur as load is applied to the motor. Set the IR Compensation (P5) to remove this effect, note excessive adjustment may cause instability.

Operating the Converter 4-6

- Adjust stability Potentiometer (P3) to improve transient response, note excessive adjustment may cause instability.

Note: *The IR compensation potentiometer (P5) must be fully anticlockwise in Tachogenerator control, adjustment will cause instability.*

- Monitor the armature current as indicated on terminal 6 the current meter output, verify that that at steady state the current does not exceed the controller rating, i.e. the voltage on T6 is not greater than 5V with SW8 OFF.

LED INDICATIONS

LED Indications

LED1	STALL TRIP	Illuminated when controller detects a Stall Condition. This is determined by the state of the Speed Loop if Speed control is lost a Stall condition is determined a Trip will occur after 60 seconds. The motor may not be stationary.
LED2	POWER ON	Illuminated when power supplied to Auxiliary Supply either directly or via the Auxiliary terminal.
LED3	OVERCURRENT	Illuminated when Armature Current exceeds 3½ times Calibrated Current.

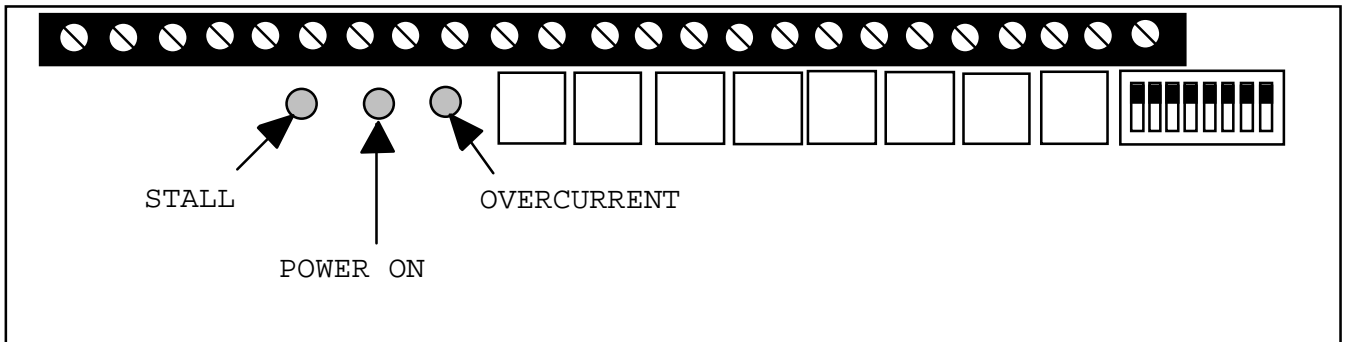

TERMINAL DESCRIPTIONS

Control Terminals

TERMINAL	FUNCTION	DESCRIPTION	NOTES
T1	Tacho Feedback	Motor Mounted Tachogenerator Input. Proportional to Motor Speed	+ 350 Vdc Max. Approx. 110 kohm.
T2	Not Connected		
T3	Speed Meter Output	Analogue Output, 0 to +10V for 0 to 100% speed.	5mA output S/C protected
T4	Minimum Speed	Setpoint Potentiometer return, minimum speed adjustable 0 to 30% with 10K setpoint potentiometer.	Must be used in conjunction with a setpoint potentiometer
T5	Run	Digital Input to Run Controller. +10V to +24V to Run. 0V to Stop.	
T6	Current Meter Output	Analogue Output, 0 to +10V Scaling SW8 = On 5V= 100% Calibrated Current SW8 = Off 5V= 100% Controller Current	5mA output S/C protected
T7	Torque/Current Limit	Analogue Input, 0 to +7.5V = 0 to 150% of Calibrated Current	
T8	0V Common	Analogue / Digital Signal Common	
T9	Setpoint Ramp O/P	Analogue Output, 0 to +10V = 0 to 100% Ramped Setpoint	5mA output S/C protected
T10	Aux. Speed Setpoint	Analogue Input, 0 to +10V = 0 to 100% Speed	approx 100 kohm
T11	0V Common	Analogue / Digital Signal Common	
T12	Total Setpoint O/P	Analogue Output, 0 to +10V = 0 to 100% Speed	5mA output S/C protected
T13	Setpoint Ramp I/P	Analogue Input, 0 to +10V = 0 to 100% Speed	approx 100 kohm
T14	+10V Reference	Analogue Output, +10V Reference for Speed/ Current Setpoints	5mA output S/C protected
T15	Stall Override	Digital Input to Override Stall Detection +10V = Override	approx 100 kohm
T16	-10V Reference	Analogue Output, -10V Reference for Speed/ Current Setpoints	5mA output S/C protected
T17	Not Connected		
T18	Not Connected		
T19	Health Output	Digital Output, +24V = Healthy	50mA Source Unprotected
T20	Not Connected		
T21	Not Connected		
T22	Not Connected		
T23	Zero Speed Output / Zero Setpoint Output	Digital Output, +24V = Running 0V = Stopped	50mA Source Unprotected
T24	Not Connected		

6-2 Terminal Descriptions

Power Terminals

TERMINAL	FUNCTION	DESCRIPTION	NOTES
L1	AC Input Line 1	Mains Supply Line1 Input	
L2/N	AC Input Line2/ Neutral	Mains Supply Line2 Input or Neutral	Must also be used as Auxiliary Supply Return when Auxiliary Supply Input used.
A+	Armature Positive	Motor Armature Positive Output.	
A-	Armature Negative	Motor Armature Negative Output.	

Field Terminals (Auxiliary Supply)

TERMINAL	FUNCTION	DESCRIPTION	NOTES
F+	Field Positive	Motor Field positive DC Output	
F-	Field Negative	Motor Field negative DC Output	
FL1	Field Rectifier Supply	Mains Supply Input Field Rectifier	
FL2	Field Rectifier Supply	Mains Supply Input Field Rectifier	
Aux L1	Auxiliary Supply	Auxiliary Supply Input to Control Transformer.	Auxiliary Supply Return via L2/N

FAULT FINDING

Troubleshooting

PROBLEM	POSSIBLE CAUSE	REMEDY
No "Power On" LED 2 Illuminated	No Supply Available	Check Supply Availability and Supply Fuse fitted or Circuit Breaker closed.
	Incorrect Supply Voltage Applied to Controller	Check Supply Voltage and Transformer Tapping position are compatible.
Motor will not run at Switch On	Start/Run Signal not present	Check Control Circuit Wiring
	No Speed Setpoint	Check Total Setpoint terminal 12. Check Setpoint Potentiometer & Wiring
	No Armature Current	Check P4 adjustment & External Current Limit Potentiometer setting & wiring (if used)
	No Field	Check Field AC Supply and Field connections
	Motor Jammed	Free Obstruction
Motor Runs and Stops after short period with "Stall" LED1 Illuminated	Incorrect Current Limit Setting	Check P4 setting Check external current limit setting
	Incorrect Current Calibration	Check Programming Switches SW5,6,7
	Motor Jammed	Free Obstruction
	Incorrect Feedback Voltage Calibration	Check Feedback Voltage Calibration Switches SW1/2. Note These Switches must be set for both Tachogenerator & Armature Voltage Feedback
	Maximum Controller Output Exceeded	Check compatibility of Motor Voltage to Controller Output Voltage
	Faulty Tachogenerator and/or Coupling.	Check Tachogenerator (use Armature Voltage Feedback Temporarily)
Motor runs at Full Speed only	Incorrect Tachogenerator Polarity or Open Circuit Tachogenerator	Check Tachogenerator viability and connectivity
	Open Circuit Speed Setpoint Potentiometer	Check Terminal 13 or 10 as appropriate
	Minimum Speed Setting	Check Minimum Speed Potentiometer P6
Motor runs with Zero Setpoint.	Zero Speed Offset Adjustment	Adjust P8 to give Zero Speed
Motor Speed Oscillating	Stability P3	Reduce P3
	IR Compensation P5	No IR compensation for Tachogenerator Feedback. Reduce P5 for Armature Voltage Feedback

ROUTINE MAINTENANCE AND REPAIR

Caution

Maintenance and repair should only be performed by competent persons using only the recommended spares. Use of incorrect parts may create a hazard and risk of injury.

Routine Maintenance

Periodically inspect the Converter for build-up of dust or obstructions that may affect ventilation of the unit. Remove this using dry air.

Repair

There are no user-serviceable components.

IMPORTANT: MAKE NO ATTEMPT TO REPAIR THE UNIT - RETURN IT TO EUROTHERM DRIVES.

Returning the Unit to Eurotherm Drives

Please have the following information available:

- The model and serial number - see the unit's rating label
- Details of the fault

Contact your nearest Eurotherm Drives Service Centre to arrange return of the item.

You will be given a *Returned Material Authorisation*. Use this as a reference on all paperwork you return with the faulty item. Pack and despatch the item in the original packing materials; or at least an antistatic enclosure. Do not allow packaging chips to enter the unit.

Disposal

This product contains materials which are consignable waste under the Special Waste Regulations 1996 which complies with the EC Hazardous Waste Directive - Directive 91/689/EEC.

We recommend you dispose of the appropriate materials in accordance with the valid environmental control laws. The following table shows which materials can be recycled and which have to be disposed of in a special way.

Material	Recycle	Disposal
metal	yes	no
plastics material	yes	no
printed circuit board	no	yes

The printed circuit board should be disposed of in one of two ways:

1. High temperature incineration (minimum temperature 1200°C) by an incinerator authorised under parts A or B of the Environmental Protection Act
2. Disposal in an engineered land fill site that is licensed to take aluminium electrolytic capacitors. Do not dispose of in a land fill site set aside for domestic waste.

Packaging

During transport our products are protected by suitable packaging. This is entirely environmentally compatible and should be taken for central disposal as secondary raw material.

REPLACEMENT OF 512 WITH 512C

512C/512 Terminal Differences

TERMINAL	512C	512	COMMENTS
T1	Tacho Feedback	Tacho Feedback	
T2	Not Connected	Not Connected	
T3	Speed Meter Output	Speed Meter Output	
T4	Minimum Speed	Minimum Speed	
T5	Run	Run	Active High on 512C
T6	Current Meter Output	Current Meter Output	
T7	Torque/Current Limit	Torque/Current Limit	
T8	0V Common	0V Common	
T9	Setpoint Ramp O/P	Setpoint Ramp O/P	
T10	Aux. Speed Setpoint	Aux. Speed Setpoint	Rescaled to be Normalised to Setpoint Ramp I/P.
T11	0V Common	0V Common	
T12	Total Setpoint O/P	+12V	Undesirable to Provide access to PS Rails. Total Setpoint Output is a useful alternative.
T13	Setpoint Ramp I/P	Setpoint Ramp I/P	
T14	+10V Reference	+10V Reference	
T15	Stall Reset.	Stall Reset	Signal Level Revised.
T16	-10V Reference.	-12V	Undesirable to provide access to PS Rails. -10V Reference useful alternative.
T17	Not Connected. *	Not Connected	
T18	Not Connected. *	Health Relay. N/C	Relay removed.
T19	Health Output	Health Relay. Co	Relay Removed. Transistor O/P.
T20	Not Connected*	Health Relay. N/O	Relay removed.
T21	Not Connected*	Not Connected	
T22	Not Connected*	Zero Speed Relay. N/C	Relay removed.
T23	Zero Speed Output / Zero Setpoint Output	Zero Speed Relay. Co	Relay Removed. Transistor O/P.
T24	Not Connected*	Zero Speed Relay. N/O	Relay removed.

* Relays must be provided externally.

9-2 Replacement of 512 with 512C

Functional Differences 512C & 512

Switches	Switch 4 now selects Zero Speed or Zero Ramped Setpoint.
Ramps	Maximum Time Increased to 40 seconds.
Overload	Now 60 seconds at 150%.
Run	Signal Level now active High to Eliminate Safety Hazard and Enable common switching.
Total Setpoint	Total Setpoint Sum at Terminal 12
-10V	-10v Reference for System applications.
Zero Offset	Speed Trim Adjustment at Zero Setpoint.
Aux. Speed Setpoint	Normalised to Ramp Setpoint.
Relays *	Removed to give spare terminals for Additional Functions.
Auxiliary	Additional Auxiliary Supply terminal to allow use on other Mains Supply Voltages
EMC	Complies with EMC Directive.

* Relays must be provided externally.



WARNING

THE 512C IS NOT A DIRECT REPLACEMENT FOR THE 512 IT IS FUNCTIONALLY EQUIVALENT.

WHEN A 512C IS USED TO REPLACE A 512 WITH THE HEALTH AND/OR ZERO SPEED RELAYS UTILISED, EXTERNAL RELAYS MUST BE PROVIDED.

CARE MUST ALSO BE TAKEN TO AVOID CONNECTING LIVE PARTS TO THE RELAY OUTPUT DRIVER TERMINALS.

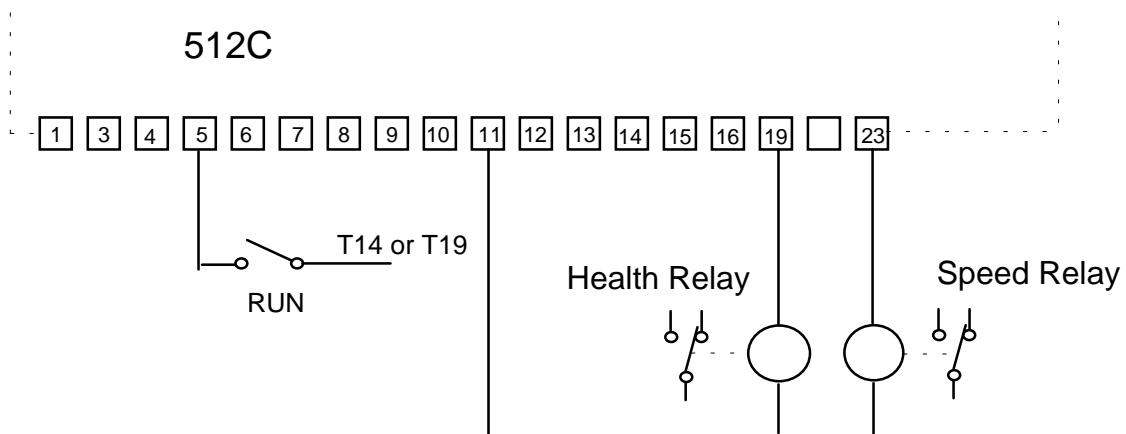

The 512C needs two external relays to become directly compatible with the 512 and the 'Run' terminal must be rewired to provide a high level input to 'Run'. Existing wiring to the 'Health' and 'Zero Speed' relay contacts must be relocated to the external relays. The Run signal is valid for Signal Levels from +10 to 24V DC and can be driven from either T14 (+10V) or T19 (Health).

The 'Zero Output' terminal on the 512C must be selected to 'Zero Speed' output by ensuring that SW4 is 'On'.

BLOCK DIAGRAM

Block Diagram

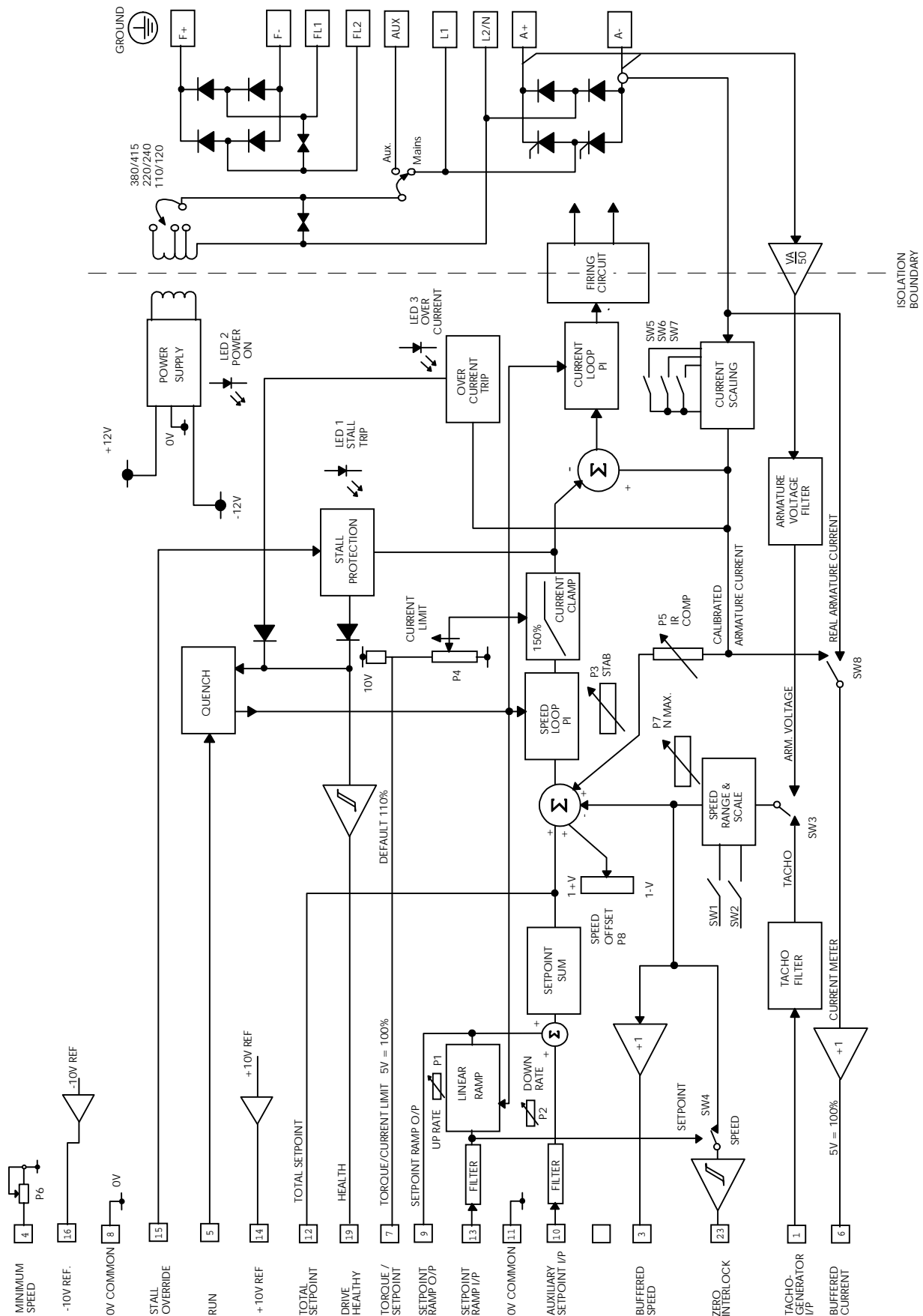

TECHNICAL SPECIFICATIONS

Environmental Requirements

Enclosure	Chassis Mounting IP00.
Operating Temperature	0 to +40°C. (Derate 1.5%/Degree above 40°C)
Humidity	85% R.H. at 40°C. (non condensing)
Altitude	Above 1000m derate at 1% / 100m.
Storage Temperature	-25°C to +55°C
Transport Temperature	-25°C to +70°C
Climatic Conditions	Class 3k3, as defined by EN50178 (1998)

Operating Conditions

Installation Category	Overvoltage Category III	
Pollution	Pollution Degree 2.	
Maximum Supply Voltages (Derived from a 3-phase supply)	480Vac L - L	Non earth referenced (IT) or earth referenced (TN)
	480Vac L - N	Earth referenced (TN)

Wiring

- Control Cabling 0.75sq.mm minimum.
- Power cable to be minimum 600V AC rated at 1.5 x armature current.
- High speed semi-conductor fuses of the correct rating are recommended controller semi-conductor protection, as the 512C is not internally fused. The suitability of the semi-conductor fuse branch protection should be decided by the installer.
- Ensure a protective earth connection is made compatible with the rating.
- Isolated control wiring should not be run close to the power cabling. If screened cables are used (recommended on setpoints and tachogenerators) connect screens to earth only at controller end.
- Eurotherm Drives can supply fuse assemblies which can be bulkhead mounted and also act as convenient supply isolators.

	Function	Rating	Cable Size	Fuse Isolator Kit	Fuse Rating	ED Part No.
512C/04	Supply	6A	1.5mm ² /16AWG	LA057605U012	12A fuse	CH390123
	Motor	4A	1.5mm ² /16AWG			
	Ground		1.5mm ² /16AWG			
512C/08	Supply	12A	2.5mm ² /14AWG	LA057605U016	16A fuse	CH390163
	Motor	8A	2.5mm ² /14AWG			
	Ground		2.5mm ² /14AWG			
512C/16	Supply	24A	6mm ² /10AWG	LA057605U032	32A fuse	CH390323
	Motor	16A	6mm ² /10AWG			
	Ground		6mm ² /10AWG			
512C/32	Supply	48A	16mm ² /6AWG	LA057605U050	50A fuse	CH390054
	Motor	32A	16mm ² /6AWG			
	Ground		16mm ² /6AWG			
ALL	Field	3A	1.5mm ² /16AWG	LA054664	10A	CH230014

Table 11.1 Recommended Cable Sizes.

Note: The cable sizes shown are based on a Form Factor of 1.5 and an overload allowance of 110% (giving a multiplier of 1.65), they are selected for the notional rating of each controller. Smaller cable may be used if the controller is calibrated at a lower current level.

Terminal Tightening Torques

Control & Field	0.6 Nm	0.4 lbf-ft	4.5 lbf-in
Power	2.7 Nm	2 lbf-ft	24 lbf-in
Earth	7.1 Nm	5.25 lbf-ft	63 lbf-in

11-3 Technical Specifications

Electrical Ratings

INPUT RATINGS	SYMBOL	512C/04	512C/08	512C/16	512C/32
Supply Voltage	Vs	110/120 220/240 Vac ± 10% 380/415 460/480 ⁽¹⁾			
Supply Current	Is	6A	12A	24A	48A
Supply Frequency	fs	50/60 Hz ± 5 Hz			
OUTPUT RATINGS					
Nominal Armature Voltage	Va	90 Vdc at 110/120 Vac 180 Vdc at 220/240 Vac 320 Vdc at 380/415 Vac			
Maximum Armature Current	Ia	4A dc ±10%	8A dc ±10%	16A dc ±10%	32A dc ±10%
Armature Current Calibration	Ical	0.5 to 4A in 0.5A steps	1 to 8A in 1A steps	2 to 16A in 2A steps	4 to 32A in 4A steps
Nominal Motor Power at 320 Vdc Armature	Pm Hp	1.125kW 1 1/2 Hp	2.25 kW 3 Hp	4.5 kW 6 Hp	9 kW 12 Hp
Overload		150% for 60 seconds			
Field Current	If	3 A dc			
Field Voltage	Vf	0.9 X Supply Voltage (Vs)			
Maximum Armature Form Factor		1.5			
Thyristor I ² t		300 A ² s			
Typical Controller Dissipation at Ia		15W ⁽²⁾	25W ⁽²⁾	50W ⁽²⁾	75W ⁽²⁾
Earth Leakage Current at 480Vac		Without Filter	-	5mA ⁽³⁾	
		With Filter	-	50mA	

Note:

1. 460/480 Vac Operation is available when used with an auxiliary supply input of a suitable standard value.
2. See page 3-2 for filter watt loss information.
3. Permanent earthing mandatory.

CERTIFICATION FOR THE CONVERTER

Caution

The integration of this product into other apparatus or systems is not the responsibility of Eurotherm Drives Limited, with respect to applicability, effectivity, or safety of operation of the other apparatus or systems

EMC and the 'CE' Mark

'CE' EMC Responsibility

The subject of CE marking and EMC is explored in more detail in a separate Eurotherm Application manual entitled 'EMC Installation Guidelines for modules and systems', part number HA388879, available from your local Eurotherm Drives office. The following sections are the minimum necessary for installation and basic understanding.

Eurotherm Drives are adhering to the CEMEP recommendations on 'CE' marking for EMC. According to SI No. 2372, implementing the EMC directive into UK law, the requirement to CE mark for EMC, applies only to **relevant apparatus** that has '**intrinsic function**' to the **end user** and which is placed on the market (**supplied**). The majority of drive modules/systems sold by Eurotherm Drives will be incorporated into a higher system/apparatus or machine which includes (at least) the motor, cable and a driven load before providing intrinsic function to the end user. As such the majority of Eurotherm Drives products are categorised as **components** (CEMEP validity field 2) and it would be incorrect for Eurotherm Drives to apply the CE mark or produce an EC Declaration of Conformity in respect of EMC. It is the manufacturer/supplier/installer of the relevant apparatus (with the intrinsic function to the end user) who must demonstrate conformance to the EMC directive

However, in a minority of cases, single drives may have intrinsic function to the end user. An example is that of '**add on**' intrinsic function, where an existing fixed speed motor application (such as a fan or a pump) is converted to variable speed with an **add on** drive module (CEMEP validity field 1). In this application Eurotherm Drives CE mark its drive module and issue an EC declaration of conformity. Because the validity of the 'CE' mark for EMC is not known when the product is manufactured, the 'CE' mark will be applied via the product manual, and will not be on the product label. From 1997, when the 'CE' mark for the Low Voltage Directive becomes mandatory, the CE mark will appear on the product label, but its validity for EMC can only be identified from the product manual.

The validity of the 'CE' mark can be identified from the flowchart in figure 12.1, refer to SI No. 2372 for clarification of relevant apparatus.

To assist manufacturers/suppliers/installers of relevant apparatus, the Eurotherm Drive 512C modules are EMC compliant to EN50081-1 (1992), EN50082-1 (1992), EN50081-2 (1994) and prEN50082-2 (1992), when fitted with the specified filter and installed according to these instructions, as confirmed by the Manufacturers EMC declaration to be found at the end of this chapter. Manufacturers/suppliers/installers of relevant apparatus (CEMEP validity fields 3 & 4) may use this compliance as a basis for their own justification of overall compliance with the EMC Directive.

It must be clearly understood by the customer before installation commences who is legally responsible for conformance with the EMC Directive. Misappropriation of the CE mark is a criminal offence.

12-2 Certification for the Converter

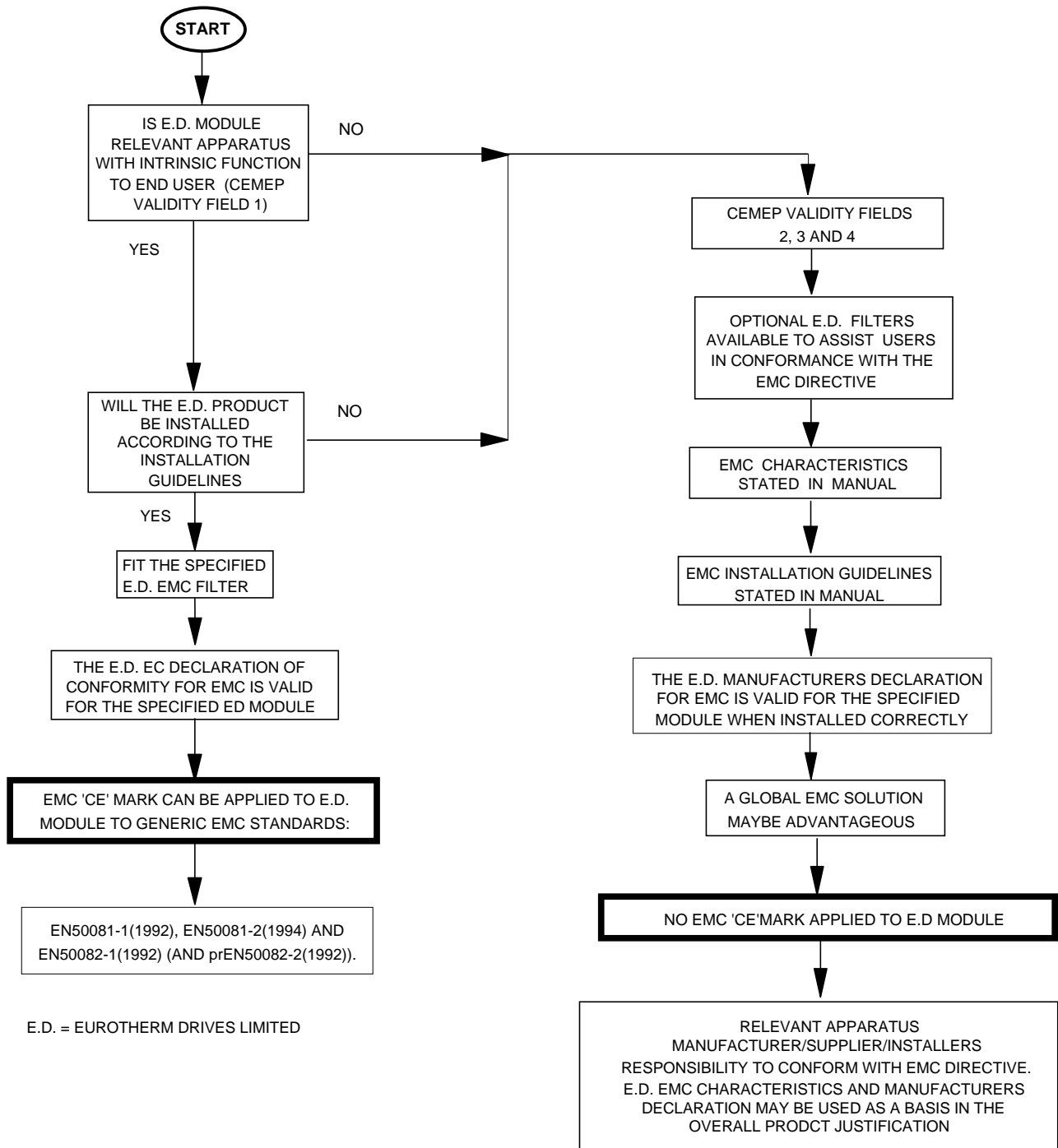

Figure 12.1 Eurotherm EMC 'CE' Mark Validity Chart

Special Considerations for Installations Requiring Compliance with UL Standards

Terminations

UL Compression Lug Kits are available for the controllers which provide sets of lugs suitable for the following ratings. These lugs must be applied with the correct tooling as described in the Installation Instructions provided with each kit.

The following terminal kits are available for the connection of Power Cabling.

Kit Part No.	Output Rating	No. of Lugs	Purpose	Wire Size
LA389745U016	16A	2	AC	8 AWG (8.4mm ²)
		2	DC	10 AWG (5.3mm ²)
		2	GROUND	10 AWG (5.3mm ²)
LA389745U032	32A	2	AC	4 AWG (21.2mm ²)
		2	DC	6 AWG (13.3mm ²)
		2	GROUND	10 AWG (5.3mm ²)

The above wire sizes for AC and DC terminations are based on a form factor of 1.5 and an overload requirement of 150% as specified in UL Standard 508C.

Motor Overload Protection

An External Motor Overload Protective Device must be provided by the Installer. This device can comprise of a Thermal Sensor within the Motor Winding monitored by an external Relay but this combination cannot be evaluated by UL, hence it is the responsibility of the installer / local inspector to determine whether the combination is in compliance with the National Electric Code or Local Code requirements.

Short Circuit Protection Requirements

UL Listed (JDDZ) non-renewable cartridge fuses, rated 300V AC or 600V AC (as appropriate depending on the rated input voltage of the drive), must be installed upstream of the drive.

	Function	Rating	Cable Size	Fuse Rating
512C/04	Supply	6A	1.5mm ² /16AWG	10A fuse
	Motor	4A	1.5mm ² /16AWG	
	Ground		1.5mm ² /16AWG	
512C/08	Supply	12A	2.5mm ² /14AWG	15A fuse
	Motor	8A	2.5mm ² /14AWG	
	Ground		2.5mm ² /14AWG	
512C/16	Supply	24A	6mm ² /10AWG	30A fuse
	Motor	16A	6mm ² /10AWG	
	Ground		6mm ² /10AWG	
512C/32	Supply	48A	16mm ² /6AWG	60A fuse
	Motor	32A	16mm ² /6AWG	
	Ground		16mm ² /6AWG	
ALL	Field	3A	1.5mm ² /16AWG	10A

Short Circuit Rating

Models Rated More than 1HP.

These controllers are suitable for use on a circuit capable of delivering not more than 5000 RMS symmetrical amperes, 480 V Maximum.

Field Wiring Temperature Rating



Use 60°C or 60/75°C Copper Conductors only.

Grounding

The field grounding terminal is identified by the International Grounding Symbol  (IEC Publication 417, Symbol 5019).

12-4 Certification for the Converter

Certificates

512C				
		EC DECLARATIONS OF CONFORMITY Date CE marked first applied: 06.12.1996		
EMC Directive		Low Voltage Directive		
In accordance with the EEC Directive 89/336/EEC and amended by 92/31/EEC and 93/68/EEC, Article 10 and Annex 1, (EMC DIRECTIVE) We Eurotherm Drives Limited, address as below, declare under our sole responsibility that the above Electronic Products when installed and operated with reference to the instructions in the product manual (provided with each piece of equipment) using the specified EMC filters to which this declaration refers is in accordance with the following standards:- BSEN50081-1(1992), BSEN50081-2 (1994), BSEN50082-1# (1998) and draft prEN50082-2#* (1992)		In accordance with the EEC Directive 73/23/EEC and amended by 93/68/EEC, Article 13 and Annex III, (LOW VOLTAGE DIRECTIVE) We Eurotherm Drives Limited, address as below, declare under our sole responsibility that the above Electronic Products when installed and operated with reference to the instructions in the Product Manual (provided with each piece of equipment), is in accordance with the following standard :- EN50178 (1998)		
MANUFACTURERS DECLARATIONS				
EMC Declaration		Machinery Directive		
We Eurotherm Drives Limited, address as below, declare under our sole responsibility that the above Electronic Products when installed and operated with reference to the instructions in the Product Manual (provided with each piece of equipment) and using the specified EMC filters to which this declaration refers is in accordance with the relevant clauses from the following standards:- BSEN50081-1 (1992), BSEN50081-2 (1994), BSEN50082-1# (1992), draft prEN50082-2#* (1992)		The above Electronic Products are components to be incorporated into machinery and may not be operated alone. The complete machinery or installation using this equipment may only be put into service when the safety considerations of the Directive 89/392/EEC are fully adhered to. Particular reference should be made to EN60204-1 (Safety of Machinery - Electrical Equipment of Machines). All instructions, warnings and safety information of the Product Manual must be adhered to.		
 _____ Dr Martin Payn (Conformance Officer)				
<i>For information only.</i> # Compliant with these immunity standards without specified EMC filters.				
EUROTHERM DRIVES LIMITED NEW COURTWICK LANE, LITTLEHAMPTON, WEST SUSSEX BN17 7RZ TELEPHONE: 01903 737000 FAX: 01903 737100 Registered Number: 1159876 England. Registered Office: Southdownview Way, Worthing, West Sussex BN14 8NN				
File Name: P:\CE\SAFETY\PRODUCTS\512C\LVDP\PRODFILE\HK389960.919 © 1999 EUROTHERM DRIVES LIMITED				
ISS:	DATE	DRN: MP	CHKD:	DRAWING NUMBER: HK389960.919
A	21.10.99	 EUROTHERM DRIVES		TITLE: Declarations of Conformity
				SHT 1 OF 1 SHTS

Issued for compliance with the EMC Directive when the unit is used as *relevant apparatus*.

This is provided to aid your justification for EMC compliance when the unit is used as a component.

The drive is CE marked in accordance with the low voltage directive for electrical equipment and appliances in the voltage range when installed correctly.

Since the potential hazards are mainly electrical rather than mechanical, the drive does not fall under the machinery directive. However, we do supply a manufacturer's declaration for

when the drive is used (as a component) in machinery.

ISS.	MODIFICATION	ECN No.	DATE	DRAWN	CHK'D
	512C Product Manual HA389196 Sheet 1 filed in drawing office.				
5	<p>Page 3-2 added Watt Loss column. Controller Warning page added:- "Signal and Control ... the user" and "It is the ... fault conditions". Under Caution added "This controller ... page 1-1").</p> <p>Page 1-1 first sentence re-written. Page 1-6 added Notes (2) and (3). Added Earth Leakage column. Page 2-1 amendments to Basic Connection diagram. Page 2-4 added grounding symbol. Page 3-3 changed sentence of Wiring information number 3). Table 3.1 changed 14AWG to 16AWG of 512C/04 Cable Size. Removed U.S. fuse rating. Chapter 6 added. Page 3-5 Special Considerations for Installations Requiring Compliance with UL Standards - considerable changes to this section.</p>	11945 11956			GDR
6	Manual brought in-line with new manual layout.	10986	15.7.97	FEP	SG
6	Manual brought in-line with new manual layout.	13636	21.10.99	FEP	JMc
7	Removed Dan Slattery from the Certificates. Added address list to back cover. Page 12-3 added UL fusing information table.	(13908) (13164) 15016	13.04.00	FEP	CM
FIRST USED ON		MODIFICATION RECORD			
File Name: I:\Manuals\512C Controller\HA389196 Issue 7\512C Manual Issue 7.doc		512C Product Manual			
 EUROTHERM DRIVES		DRAWING NUMBER			SHT. 1
		ZZ 389196 C			OF 1